



# Rules and Regulations

Effective August 5, 2021

Version 3.0



## *Organization Purpose and Structure*

The United Flyball League International (U-FLI) was founded in 2005 for the purpose of promoting the sport of Flyball by utilizing good communication among its administration, officials, and competitors. U-FLI strives to ensure fair and equal treatment for all competitors. U-FLI desires to establish the best possible Flyball organization in every aspect for competitors of all levels and to set the standard in providing a Flyball organization that promotes fairness, competitiveness and safety for both dogs and handlers. U-FLI requires ongoing training for its judges and all other officials to provide consistency for its participants.

To preserve the competitive spirit of Flyball, a Championship event is held each year.

United Flyball League International, Inc.  
PMB 169  
4132 South Rainbow  
Boulevard Las Vegas, NV  
89103  
(702) 527-UFLI (8354)  
[www.u-fli.com](http://www.u-fli.com)

## **Legal Disclosures**

© Copyright 2005 - 2021. U-FLI. All rights reserved.

All forms, content and materials presented in this document are the intellectual property of United Flyball League International, Inc. (U-FLI) and may not be copied, reproduced, distributed, or displayed in any form or manner without U-FLI's express written consent.



U-FLI and its logos (shown above) are registered trademarks of United Flyball League International, Inc.



## Table of Contents

Section 1. Participation.....	6
1.1 Club Eligibility .....	6
1.2 Dog Eligibility.....	6
1.3 Participant Eligibility .....	7
1.4 Types of Teams .....	7
1.5 Classes of Competition .....	9
Section 2. Rules of Racing .....	12
2.1 Object.....	12
2.2 Timesheets.....	12
2.3 Teams.....	12
2.4 Reporting for Racing .....	12
2.5 Forfeit Races .....	13
2.6 Warm-Ups.....	13
2.7 Heats .....	13
2.8 Infractions.....	13
2.9 False Starts .....	14
2.10 Breakout .....	14
2.11 In-Ring Interference .....	15
2.12 Outside Interference .....	15
2.13 Knocked Over Jumps.....	15
2.14 Hazards.....	15
2.15 Unsafe Behavior.....	15
2.16 Flyball Box Malfunction.....	16
2.17 Fouling in the Ring .....	16
2.18 Scoring a Heat.....	16
Section 3. Conduct During an Event .....	17
3.1 Conduct of Participants .....	17
3.2 Conduct of Dogs .....	17
3.3 Conduct of Judges .....	17
Section 4. Equipment .....	18
4.1 Jumps .....	18
4.2 Flyball Boxes .....	19
4.3 Balls.....	19
4.4 Backstop .....	20
4.5 Digital Timing System (DTS).....	20
4.6 Collars.....	20
Section 5. The Flyball Ring .....	21
5.1 Ring Size .....	21
5.2 Footing .....	21
5.3 Start/Finish Line.....	22
5.4 Jump Placement .....	22



5.5 Flyball Box Placement .....	22
5.6 Backstop Placement .....	22
5.7 Digital Timing System Placement .....	22
5.8 Markings .....	22
5.9 Box Judges.....	23
5.10 Line Judges .....	23
5.11 Timing Judges .....	23
5.12 Scoring Table .....	23
5.13 Multiple Rings.....	23
Section 6. Measuring and Jump Heights .....	24
Section 7. Points, Titles and Awards.....	26
7.1 Points.....	26
7.2 Individual Titles and Awards.....	26
7.3 Single and Pairs Awards .....	27
7.4 Junior Award of Merit.....	27
7.5 Affinity Award.....	27
7.6 U-FLI Records.....	28
Section 8. Sanctioned Events .....	30
8.1 Sanctioning .....	30
8.2 Announcement of Tournaments .....	30
8.3 Types of Tournaments - Limiting Entries .....	30
8.4 Seeding.....	30
8.5 Racing Formats.....	31
8.6 Schedules.....	31
8.7 Prizes and Awards.....	31
8.8 Tournament Director Duties and Responsibilities.....	32
Section 9. Judges and Scorekeepers .....	33
9.1 Duties and Responsibilities - Head Judge.....	33
9.2 Duties and Responsibilities - Line Judge .....	34
9.3 Duties and Responsibilities - Box Judge .....	34
9.4 Duties and Responsibilities – Scorekeeper .....	34
Section 10. U-FLI Champions.....	35
10.1 Overview.....	35
Appendix A. Schedule of Fees.....	36
Appendix B. Contact List.....	37
Appendix C. Official Forms.....	38
Pre-flight Entry Form .....	39
Singles Tournament Entry Form .....	40
Pairs Tournament Entry Form.....	41
Team Tournament Entry Form.....	42
Singles Time Sheet.....	43
Pairs Time Sheet .....	44
Team Time Sheet .....	45
Novice Junior Award of Merit Verification Form.....	46



Intermediate Junior Award of Merit Verification Form..... 47  
Advanced Junior Award of Merit Verification Form ..... 48  
Height Measurements ..... 49  
Club Waiver ..... 50  
Excusal Form – Dog ..... 51  
Excusal Form - Participant..... 52  
U-FLI Record Verification Form ..... 53



## Section 1. Participation

U-FLI events are open to all Participants (as defined in section 1.3) without discrimination who exhibit good sportsmanship and uphold the standards as set forth in U-FLI's policies, including without limitation these Rules and Regulations.

Competitors may compete with any dog, pure breed and mixed breed alike, subject to the limitations stated herein. The key elements of the sport are to demonstrate the dog's speed and agility in navigating the Flyball course. Flyball also requires that the competitor exercise sound judgment in looking after the safety of dogs and competitors.

All dogs and clubs must be registered and in good standing with U-FLI in order to compete and be eligible for awards at U-FLI sanctioned events. Dogs, clubs, and participants are deemed "in good standing" with U-FLI if they have no outstanding financial obligations to U-FLI and have no suspensions or other sanctions barring them from participating in U-FLI sanctioned events. Registration may be completed on-line at the U-FLI website (<http://www.u-fli.com>) or by submitting the appropriate forms with payment to the U-FLI mailing address. Clubs and dogs will be assessed a one-time fee upon registration. See Schedule of Fees - Appendix A.

### 1.1 Club Eligibility

A club, private training center, or other organization may affiliate with U-FLI for the purpose of promoting Flyball and U-FLI in their community as an athletic sporting event and to encourage family involvement in promoting responsible pet ownership.

Any group wishing to compete in or host U-FLI sanctioned events must be registered with U-FLI.

Clubs must designate an owner who is at least 18 years of age and will be the club contact responsible for interacting with U-FLI.

### 1.2 Dog Eligibility

All healthy, trained dogs in good standing with U-FLI that are at least twelve (12) months of age are eligible to compete in U-FLI events.

Dogs must have a Race Utility Number (RUN) issued by U-FLI prior to competing in a U-FLI sanctioned event.

Bitches in heat, dogs that are lame or recovering from surgery are ineligible for entry, as is any dog with a deformity or condition that prevents it from performing the sport safely and in a manner that is in the best interest, health, and welfare of the dog.

Any dog that the Head Judge determines is not physically able, or in enough control, to compete in a safe manner will be excused from the event.

Dogs entered in any sanctioned class at a U-FLI tournament must be able to correctly perform the behaviors required of that class of competition. Dogs deemed not ready for competition, except for dogs entered in Pre-Flight, at the discretion of the Head Judge and/or the U-FLI Representative, will be dismissed from the remainder of the heats in that class of competition for the remainder of the tournament.

U-FLI accepts registration of any dog. Pure breeds recognized for registration are dogs included on the breed lists for the Federation Cynologique Internationale (FCI), the United Kennel Club (UKC), the American Rare Breed Association (ARBA), the American Kennel Club (AKC), and the American



Herding Breed Association (AHBA).

### **1.3 Participant Eligibility**

To be eligible to participate in U-FLI events, an individual must register as a "Participant" with U-FLI (<https://www.u-fli.com/handlernew.php>). Participants must be in good standing with U-FLI. A Participant who is not in good standing with U-FLI will have their Participant status terminated.

### **Determinations Regarding Participant Eligibility and Standing**

1. The U-FLI Board of Directors will determine whether an individual is eligible to be a Participant and/or whether a Participant is in good standing with U-FLI. The Board may, for cause, deny or terminate an individual's status as a Participant. The Board's decision with respect to an individual's status as a Participant is final and may not be appealed.
2. The U-FLI CEO may submit to the U-FLI Board of Directors a written complaint alleging that an individual is not eligible to be a Participant or that a Participant is not in good standing with U-FLI. The complaint shall contain a short and plain statement of the allegations and grounds for denying or terminating Participant status. Grounds for denying or terminating Participant status include, but are not limited to, violation of any law or any U-FLI, host site, or host clubs' rules, policies, or bylaws.
3. Within 10 business days after receipt of the complaint, the Board of Directors will: (a) provide a copy of the complaint and any attachments to the individual or Participant; and (b) notify the individual or Participant that he/she may submit a written response to the complaint within 10 business days of the notification.
4. The Board may, for cause, suspend a Participant's ability to participate in any U-FLI events and/or prohibit a Participant from being present on the grounds of any U-FLI event pending the Board's decision regarding his/her Participant status. Grounds for such a suspension include, but are not limited to, allegations of unsportsmanlike conduct, abusive treatment, or other similar safety concerns.
5. Within 30 business days after either the individual or Participant submits a written response to the complaint or the deadline to submit a written response has passed, whichever occurs first, the Board of Directors will make its decision regarding the individual's eligibility or the Participant's status (as applicable).
  - a. In making its decision, the Board of Directors will consider all information that it deems appropriate, including but not limited to the complaint, the individual or Participant's written response (if any), and U-FLI's Rules and Regulations.
  - b. The Board of Directors may issue any resolution that it deems appropriate, up to and including permanent denial or termination of Participant status.
6. U-FLI will provide to the individual or Participant a copy of the Board of Directors' written decision.

### **1.4 Types of Teams**

#### **Regular Teams**

A Regular Team consists of the following:

- A minimum of four dogs and four handlers not to exceed six dogs and six handlers.
- A Box Loader.
- Optionally a team may have a Pass Caller and other participants in the ring to aid the team. At no time may these optional participants interfere with the judges or the opposing team.

Dogs and participants must meet all U-FLI eligibility requirements. Once a dog has competed with a club's Regular Team, it is ineligible to race with a different club's Regular Team for a period of 90 days. Noncompliance shall result in forfeiture of U-FLI points, tournament points, U-FLI records, and U-FLI rankings for all dogs in all heats in the class(es) from which the violation first occurs where



the offending dog has run.

Regular Teams may enter Standard and/or Variety Classes of competition. Regular Teams will earn U-FLI points, are eligible for placement in the tournament, and are eligible for ranking in the U-FLI Database.

## **Exhibition Teams**

Exhibition Teams are created after racing starts when Regular or Pickup Teams have had a loss of one or more of their team dogs that prevents them from competing further in the tournament. Should a Regular or Pickup Team lose a dog during a tournament they may replace the dog with another eligible dog from any club to finish the tournament. Once a Regular Team becomes an Exhibition Team, all heats raced as an Exhibition Team will be converted to losses, they cannot set a recognized U-FLI record, nor be ranked in the U-FLI Database. Races against Exhibition Teams will be played out as if the Exhibition team were a Regular team. When racing in a 3 of 5 format, it will be played to completion. However, once the race is over, all heats for the Exhibition team will be converted to losses and the Regular team, upon successful completion, will be awarded the win of the race by the Scorekeeper. All accomplishments of a Regular Team prior to becoming an Exhibition Team shall still be valid for placements, records, and rankings. All dogs competing with the Exhibition Team will continue to earn U-FLI points. All rules of racing continue to apply.

The exhibition dog will be designated on the timesheet by listing that dog's RUN#, name and jump height in the "E" row of the timesheet.

## **Pickup Teams**

A Pickup Team is created prior to the start of racing and consists of the following:

- A minimum of four dogs and four handlers not to exceed six dogs and six handlers.
- At least one of the dogs that runs must be from a different club or have no club affiliation and must run in at least one heat.
- A Box Loader.
- Optionally a team may have a Pass Caller and other participants in the ring to aid the team. At no time may these optional participants interfere with the judges or the opposing team.
- Any dog from any club may compete with another club as a Pickup Team. Dogs need not be from the same club nor do they need to belong to a club.

Dogs and participants must meet all U-FLI eligibility requirements. Pickup Teams may enter Standard and/or Variety Classes of competition and are eligible to convert to an Exhibition Team during racing should it become necessary. Pickup Teams will earn U-FLI points. Races against Pickup Teams will be played out as if the Pickup team were a Regular team. When racing in a 3 of 5 format, it will be played to completion. However, once the race is over, all heats for the Pickup team will be converted to losses and the Regular team, upon successful completion, will be awarded the win of the race by the Scorekeeper. Pickup Teams are ineligible for placement in the tournament, cannot set recognized U-FLI records, cannot win heats, and will not be ranked in the U-FLI Database.

## **Pairs Teams**

A Pairs Team consists of the following:

- Two dogs and two handlers.
- A Box Loader.
- Optionally a team may have a Pass Caller and other participants in the ring to aid the team. At no time may these optional participants interfere with the judges or the opposing team.





- Dogs need not be from the same club nor do they need to belong to a club.

Dogs and participants must meet all U-FLI eligibility requirements. Pairs Teams will not earn U-FLI points. Only a Pairs Team's best time will be recorded and ranked in the U-FLI Database. A Pairs Team must post at least one completed heat to be eligible for completion of a leg toward the Pairs Racer title.

## **Singles Teams**

A Singles Team consists of the following:

- One dog and one handler.
- A Box Loader.
- Optionally a team may have other participants in the ring to aid them. At no time may these optional participants interfere with the judges or the opposing team.
- Dogs need not belong to a club.

Dogs and participants must meet all U-FLI eligibility requirements. Singles Teams will not earn U-FLI points. Only a Singles Team's best time will be recorded and ranked in the U-FLI Database. A Singles Team must post at least one completed heat to be eligible for completion of a leg toward the Single Dog Racer title.

## **1.5 Classes of Competition**

During a U-FLI sanctioned tournament, no dog can compete in more than 3 different classes or compete on more than one team in the same class each tournament. Noncompliance shall result in forfeiture of U-FLI points, tournament points, U-FLI records, and U-FLI rankings for all heats in the class(es) in which the violation first occurs where the offending dog has run.

The only exception is when one tournament is held over two days, in this case Singles and Pairs teams may place an entry for each of the tournament days without penalty.

### **Standard Class**

The Standard Class of competition must be offered at each U-FLI sanctioned tournament. The Standard Class shall be open to any breed or mix of dog meeting the U-FLI eligibility requirements subject to local governing laws for the event. The host club shall determine if the class is limited upon sanctioning.

Teams will be grouped in divisions based on submitted seed times.

### **Special Classes**

In addition to offering Standard Classes, clubs may also offer one or more Special Classes at U-FLI sanctioned tournaments, described as follows. Dogs and Participants must meet all U-FLI eligibility requirements. The host club shall determine if the class is limited upon sanctioning.

#### **Variety Class**

Teams must consist of at least four different breeds of dogs. During competition, no two dogs in a team's line-up may be of the same breed. Please refer to Section 1.2 for a listing of U-FLI recognized registries. Mixed breed dogs may participate in this class; however, a mixed breed dog shall be considered as a breed on the racing roster and only one mixed breed dog may run in a racing line-up.

Teams will be grouped in divisions based on submitted seed times.



### **Pairs Class**

Only Pairs Teams may enter the Pairs Class.

The Rules of Racing (Section 2) will be observed except that:  
Pairs Teams shall choose their desired U-FLI jump height.

Whenever possible, Pairs Teams shall race other teams of similar speeds. Each team will be given two races with four heats to set their best possible time. Pairs Teams will be ranked by fastest time. The reaction time of the handler will be included in the team's time. In the event of a "bye" race the competing pairs team may supply a courtesy team to race against. The courtesy team's times will not be recorded, no titles awarded, or no false starts rerun. The courtesy team must sign a release form and meet all U-FLI eligibility requirements.

Infractions will not be rerun and will result in a "No Finish" (NF) with no recorded time. The heat is not awarded a Win, Loss or Tie, only the time is recorded on the Scoresheet.

The fastest time of the Pairs Team for that tournament will be tracked by U-FLI and will be available via the U-FLI website.

### **Singles Class**

Only Singles Teams may enter the Singles Class.

The Rules of Racing (Section 2) will be observed except that:  
Handlers shall choose their desired U-FLI jump height.

Whenever possible, dogs shall race dogs of similar speeds. Each dog will be given two races with four heats to set their best possible time. Dogs will be ranked by fastest time. The reaction time of the handler will be included in the dog's time. In the event of a "bye" race the competing singles team may supply a courtesy team to race against. The courtesy dog's times will not be recorded, no titles awarded, or no false starts rerun. The courtesy team must sign a release form and meet all U-FLI eligibility requirements.

Infractions will not be rerun and will result in a "No Finish" (NF) with no recorded time. The heat is not awarded a Win, Loss or Tie, only the time is recorded on the Scoresheet.

The fastest time of the dog for that tournament will be tracked by U-FLI and will be available via the U-FLI website.

If a dog in this class is deemed not race ready by the head judge, at the judge's discretion, may be allowed to move to the Pre-Flight Class, if offered for the remaining race.

### **Pre-Flight Singles Class**

Only individual dogs who are registered with U-FLI and at least twelve (12) months of age may enter the Pre-Flight Class. Dogs entered in this class cannot be entered in any other class.

This class is intended for dogs that are unable to race head-to-head with an opponent. The dog entered in the Pre-Flight class is not required to run against/with another dog, however, the Pre-Flight team has the option of allowing one (1) additional dog/handler team in the ring to race against/with. All dogs must have a RUN. No judges are required; however, the participant may provide their own 'judges' if they desire. If at any time during a pre-flight race the head judge, tournament director, or U-FLI Rep deem the activities to be unsafe, the handler may be asked to cease those activities.

This class can be offered by the Host club before, during or after regular racing. There will be no



U-FLI points awarded, and no times will be recorded.

Dogs entered in this class will be given two 7-minute periods. No warmup period will be given.

Pre-Flight teams may use the time to work on whatever aspect of flyball they desire but may not use the DTS, except as a 7-minute countdown timer. Pre-Flight teams will be allowed to use gating and/or props as long as they are removed prior to the end of the 7-minute race period. They may choose their desired jump height and can use one or both lanes as the participant chooses.

Dogs entered in this class are not required to use the full 7-minute period, however once the dog that is listed on the Pre-flight Entry Form leaves the ring, the Pre-Flight time is over. Teams may not substitute another dog for the dog listed on the Pre-flight Entry Form during the 7-minute time frame.



## **Section 2. Rules of Racing**

### **2.1 Object**

Flyball is a race in which each dog on the team, in relay fashion, hurdles over each of the four jumps in order, and triggers the pedal on the Flyball box, which releases the ball. The dog retrieves the ball and returns over all four jumps in a row, with the ball in its mouth, carrying it completely over the Start/Finish line. Only when the first dog has returned to the Start/Finish line, with any part of its body, may the second dog reach the Start/Finish line with any part of its body and so forth until all dogs, including any dogs that must rerun due to infractions, have completed. The first team to successfully complete the course is declared the winner of the heat.

### **2.2 Timesheets**

A completed timesheet listing racing dogs for each entered team must be turned in to the Scorekeeper before the team's division begins. All dogs listed on the timesheet must meet all U-FLI eligibility requirements. Teams will forfeit tournament placement, U-FLI Records, and recording of U-FLI points if any dog has a missing or invalid RUN.

### **2.3 Teams**

For each heat, the team must indicate to the Line Judge, which dogs will be running. Once the heat has begun, alternate dogs may not be substituted. In the Standard and Variety classes, four dogs will be selected to run. (In the Pairs and Single Dog Classes, the dogs are already pre-selected.

Of the four dogs selected to run in a heat, the dog with the shortest jump height recorded on the timesheet will determine the minimum jump height for the entire team during each heat. Teams will forfeit any heats run at a lower jump height than what is recorded on their timesheet.

Extra assistants are allowed to aid the release of a dog so long as they are behind the handler they are assisting. Once the dog has been released, they must either move promptly to the back of the ring or stay stationary until the heat has been completed.

Extra assistants that become the handler for the dog's recall must start from the dog's release point.

Extra assistants can position themselves to help keep a dog from crossing in the runback, after it completes its run if it does not interfere or distract the Judge or the opposing team and the extra assistants do not come any closer to the start/finish line than the 45' mark.

### **2.4 Reporting for Racing**

Teams are expected to report for racing on time. Delays are excused when a club has a conflict such as back-to-back races, or clubs running teams simultaneously in two rings. Teams that foresee this type of delay should notify the Head Judge or Scorekeeper as soon as possible. However, when a team fails to provide just cause and reports for a race more than five minutes late including the warm-up period, they may be assigned losses for heats in that race by the Head Judge.

Teams that do not report for racing on time without cause will forfeit their warm-up time.



## **2.5 Forfeit Races**

When a race is won by forfeit of the opposing team, the minimum number of heats must still be completed in order for the team to qualify for advancement in the tournament standings. A team may forfeit a race, or any remaining heats in a race upon providing sufficient reason to the Head Judge. If the team is forfeiting to another team from the same club, the slower seeded team must forfeit. Teams that forfeit multiple times during a tournament may be subject to surrender placement and points at the Head Judge's discretion.

## **2.6 Warm-Ups**

Prior to the start of each race, a warm-up period shall be provided. The warm-up period will commence at the conclusion of the previous race. However, if a team is delayed due to a racing conflict, the warm-up period will not begin until both teams have reported to the racing ring. Teams that do not report for racing on time, without cause, will forfeit their warm-up time. Only dogs listed on the team's timesheet are allowed to warm-up with their team during the designated warm-up period. Training devices may be used only during a team's warm-up period. All training devices must be removed from the ring once the warm-up period is over.

## **2.7 Heats**

The flyball heat will commence when the Head Judge begins the start sequence. The first dog shall not cross the Start/Finish line with any part of its body before the start sequence has been completed. All remaining dogs, after the first dog, shall not cross the Start/Finish line with any part of their bodies, until the returning dog crosses the Start/Finish line with any part of its body. Participants shall not cross the plane of the Start/Finish line with any part of their body, or with any object, such as a toy, at any time during the heat, except to reposition a knocked jump or retrieve a loose ball.

Each running dog must hurdle the jumps in sequence from the Start/Finish line to the flyball box. The dog must trigger the flyball box before retrieving the ball ejected from the box and must return over each jump, in sequence, from the box back to the Start/Finish line carrying the ball completely over each jump and completely across the Start/Finish line. Once the dog crosses the Start/Finish line with any part of its body, its turn has ended.

The box loader, after loading each ball, is required to return to an upright position. The box loader's hands should remain either stationary at his/her side or behind his/her back. The box loader is allowed to provide verbal encouragement to each dog. The box loader must stay positioned on the box, except to get a fresh supply of balls for that heat, retrieve a loose ball, or reposition a knocked jump, until the Head Judge declares the winner of the heat.

After all dogs on the team have completed this sequence and all dogs who received infractions have rerun, or the judge declares the heat over, the heat will be declared complete. The Regular team who completes the heat with the fastest time will be declared the winner of the heat.

If the Head Judge stops a heat due to a false start in error; the heat will be resumed with both teams keeping no more than one false start.

## **2.8 Infractions**

An infraction shall be signaled by the Head Judge and/or Line Judge and/or Box Judge when a dog or participant infringes on any of the rules of racing.



An infraction, whether caused by the actions of the dog, participant, or box loader, requires that the dog rerun the course in the order in which the infraction was received and after all dogs have completed their first run. An attempted run begins when the outgoing dog crosses the start finish line with any part of its body. Only one infraction will be accumulated per attempted run.

Teams unable or unwilling to rerun infractions shall be awarded a "No Finish" (NF).

Sample infractions include, but are not limited to:

- The first dog (start dog) receives a second false start.
- The dog does not take each jump in succession or goes around any jumps.
- The dog does not carry the ball back over the start/finish line in its mouth.
- The dog does not carry the ball over each jump.
- The dog takes the ball from the Flyball box before triggering the release mechanism.
- The incoming dog crosses the start/finish line before any part of the returning dog crosses the start/finish line.
- The box loader provides anything other than verbal assistance to the dog.
- Any part of the handler, or object that the handler has (such as a toy), crosses the plane of the start/finish line – except to retrieve a loose ball or to reset a knocked jump.
- A dog that has missed jumps or dropped its ball has the opportunity to correct their behavior and run the course correctly. If they cross the start/finish line prior to doing so, they will have to rerun.
- A dog must cross the start/finish line before taking its rerun.
- Any dog that crosses the start/finish line and has not completed the course will be required to rerun at the end of the lineup in order.
- A dog has until it returns over the start/finish line to correct any errors it has made.

## **2.9 False Starts**

False starts will be limited to one per race, per team. A false start occurs when any part of the first dog's body passes the Start/Finish line before the start sequence has been completed. When the first false start occurs, from either team; the head judge shall stop the heat, an infraction shall be indicated with a marker on the light tree, and the start sequence will begin again.

If a second false start is called against the same team in the same race, an infraction shall be indicated, the heat will continue, and the dog will be required to rerun at the end of the line-up for the heat to be considered complete.

If a second false start occurs concurrent with the opposing team's first false start any time during that race, the opposing team's first false start supersedes the team's second false start. The heat shall be stopped, an infraction shall be indicated with a marker on the light tree, and the start sequence shall be restarted.

## **2.10 Breakout**

To maintain competitive divisions, a one-second breakout will apply to all divisions in all classes except for the top division of each class. The breakout shall be one second faster than the top seeded team in each division.

If a team runs faster than the designated breakout time, the team will receive a loss for that heat, no U-FLI points will be awarded, and records will not be recognized. If a team breaks out three times during the tournament, the team will no longer be eligible for placement in the division and all remaining races will be scored as losses. The team will continue to receive U-FLI points for all non-breakout races. Breakout times will be recorded in the Standard and Variety divisions and can be used as the championship qualifying seed time.



In the event that both teams' breakout during a race or one team breaks out and the other does not finish, both teams will receive a loss for that heat.

If a breakout is missed and the race has completed, the scorekeeper will change the tournament records to reflect the breakout and the affected teams will be notified. Please note: additional heats may be required to determine the winner of the affected race.

### **2.11 In-Ring Interference**

When the actions from the opposing team prevent a team from completing its heat in a typical fashion, the Head Judge shall stop the heat, declare interference, and award the win and an estimated time to the disadvantaged team. The estimated time will be marked as "EST" on the team's timesheet. Estimated times will not be used in deciding the outcome of the tournament or as the team's fastest time of the tournament.

In-ring interference can be caused by a dog or handler from the opposing team crossing into the other team's racing lane, a dropped ball that has bounced into the other team's racing lane, or by other actions of dogs or people that hinder a team's ability to complete the heat in a typical fashion. The Head Judge shall determine what actions warrant the interference call.

### **2.12 Outside Interference**

When actions or events that occur outside of the Flyball Ring hinder a team's ability to complete its heat in a typical fashion, the Head Judge shall stop the heat, declare outside interference, and rerun the heat. Neither team shall be penalized. At the Head Judge's discretion, a team may be allowed to substitute an alternate dog to complete the heat. The Head Judge shall determine what actions or events warrant the interference call.

### **2.13 Knocked Over Jumps**

Dogs will not be penalized for knocking jumps over so long as each dog traverses the jump as if it were standing. A team member or helper may return the jump into its upright position without penalty, so long as doing so does not interfere with the opposing team, nor unfairly help their team. Jumps that are moved out of place and subsequently not jumped by the dogs shall be considered an infraction. The Head Judge will determine if the heat should be stopped for safety reasons.

### **2.14 Hazards**

Should the Head Judge determine there to be a safety hazard, the heat shall be stopped, the hazard removed, and the heat rerun without penalty. Any false starts earned prior to that run for that heat will remain in place for the rerun.

### **2.15 Unsafe Behavior**

During racing, behaviors that create unsafe conditions, although not directly interfering with the opposing team, shall be prohibited. Unsafe behaviors are actions taken by a participant or racing dog that may negatively impact other participants, dogs, officials, and even spectators. Actions such as, but not limited to, dogs crossing into the opposing racing lane, throwing a ball, toy, or other objects in the runback area shall be considered an "Unsafe Behavior." The Head Judge shall first make a warning regarding the behavior. Should the behavior continue, at the Head Judge's discretion, the offending team may be required to forfeit the next unfinished heat, or in the case of the last heat of the race that heat of the current race.



## 2.16 Flyball Box Malfunction

The box loader shall indicate by crossing their arms into an "X" above their head when a box malfunction occurs. The Head Judge shall stop the heat and confirm the malfunction. If the Head Judge confirms the box did malfunction, the team can switch to an alternate Flyball box or repair the malfunctioning box so long as the repair can be made in a reasonable amount of time in the opinion of the Head Judge. If the Head Judge cannot confirm the box malfunction, the heat will be scored as a loss.

## 2.17 Fouling in the Ring

If a dog urinates or defecates in the Flyball Ring from the time the team enters the ring until the time the team exits the ring, that team shall forfeit the next unfinished heat, or in the case of the last heat of the race that heat of the current race.

## 2.18 Scoring a Heat

During a heat, the first team to have all of its dogs successfully complete the course, including rerunning any infractions, will be declared the winner of the heat. The Line Judge will record the outcome of the heat by circling the appropriate outcome on the timesheet in the Result column. Below is a sample of the U-FLI timesheet:

Race #:	Race format:	Opponent:			
Heat:	Lineup (Circle Dog # from above):	Result (Circle one) / Reason	Time:	Title Points:	Tour. Scoring:
1	1 2 3 4 5 6 E	W L T NF INT B/O EST F			/
2	1 2 3 4 5 6 E	W L T NF INT B/O EST F			
3	1 2 3 4 5 6 E	W L T NF INT B/O EST F			
4	1 2 3 4 5 6 E	W L T NF INT B/O EST F			
5	1 2 3 4 5 6 E	W L T NF INT B/O EST F			
					Total Title Pts:

### Lineup Section Legend:

E = Exhibition Dog	If a team chooses to run Exhibition (see 1.4 Types of Teams) the "E" dog will be designated.
-----------------------	--

### Result Column Legend:

W = Win	A "Win" is indicated by the Head Judge typically by a pointing motion toward the winning team's lane.
L = Loss	A "Loss" is circled when the head judge awards the Win to the opposing lane and does not indicate a No Finish.
T = Tie	A "Tie" is indicated by the Head Judge.
NF = No Finish	When a team does not successfully run all of its dogs or rerun all of its infractions a "No Finish" is indicated by the head judge, typically as a back and forth sweeping motion of the hand. A No Finish is generally indicated before the Win. "NF" will be recorded on the team's timesheet and no time will be recorded in the Time column.
INT = Interference	If a team receives a loss due to interference, an "INT" will be recorded on the team's timesheet and no time will be recorded. The head judge will indicate when Interference has occurred.
B/O = Breakout	If a team runs more than one second faster than the seed time of the top seeded team in its division, the Head Judge will indicate "Breakout". A "B/O" will be recorded on the team's timesheet and no time will be recorded for that heat.
EST = Estimated Time	The head judge will indicate when an estimated time is to be used. If a team receives an estimated time, the estimated time shall be the submitted Seed Time with "EST" recorded. Estimated times will not be counted as record times, be used in determining tournament placement or recorded as an official best time.
F = Fouling	If a team receives a loss due to fouling in the ring, an "F" will be recorded on the team's timesheet and no time will be recorded. The head judge will indicate when fouling has occurred.





## **Section 3. Conduct During an Event**

U-FLI is an organization that encourages family involvement, promotes fairness, and is committed to providing a safe environment for all. A high standard of conduct must be observed by participants, dogs, U-FLI Head Judges and U-FLI Representatives.

### **3.1 Conduct of Participants**

Participants shall not engage in unsportsmanlike conduct at any time during a U-FLI sanctioned event. Unsportsmanlike conduct may include, but is not limited to swearing, harassment, lewd gestures, or remarks. Participants are expected to be respectful and courteous to judges, officials, participants, and spectators at all times. While alcohol may be permitted at U-FLI events, in accordance with local governing laws, U-FLI does not encourage alcoholic consumption during an event and does not allow for alcohol to be present in the ring. If, in the opinion of the Head Judge or U-FLI Representative, a participant is under the influence of illegal drugs, or intoxicated, they will be excused from the event and may be subject to further disciplinary action.

Abuse of dogs such as striking, kicking, or other unreasonably rough treatment or handling will not be tolerated. U-FLI shall make every effort to first educate the individual, but continuation of abusive behavior will result in expulsion from the event and a report filed with U-FLI. The Head Judge or U-FLI Representative shall determine what actions warrant further disciplinary action.

### **3.2 Conduct of Dogs**

Any dog that bites unprovoked or is an obvious threat to other dogs or people, either by attacking or through continuous and escalating aggressive behavior, may be suspended from racing for the remainder of that event weekend. Any dog excused under these conditions will be reported to U-FLI and an investigation will be conducted to determine eligibility for continued participation. Dogs may be excused from competition by the Head Judge or any U-FLI Representative.

Any dog that attacks a person or dog at a U-FLI event resulting in injury will be immediately excused from competition. The Head Judge and/or U-FLI Representative must provide a copy of the completed Excusal Form to U-FLI at [admin@u-fl.com](mailto:admin@u-fl.com) or PMB 169,4132 South Rainbow Blvd., Las Vegas, NV 89103 by the Wednesday following the event. Any dog excused for aggression may not participate in another U-FLI event until the reinstatement process is followed. Each reinstatement will be reviewed by the U-FLI Rules and Regulations Committee on a case-by-case basis.

### **3.3 Conduct of Judges**

All U-FLI Head Judges are expected to have a thorough knowledge and understanding of the U-FLI Rules of Racing, the U-FLI Policies and Procedures, as well as the U-FLI Judges Guidelines, and are required to continue enhancing their judging skills and knowledge.

Judges are required to be consistent, objective, and polite in their rulings. The Head Judge shall remain approachable both inside and outside the racing ring. The Head Judge should be willing to clarify any decisions made during the event and should view each of these interactions as an opportunity to educate both participants and spectators. The Head Judge must ensure that dogs and participants in their ring are safe above all else. Judges must demonstrate all of the attributes of good sportsmanship by example. The Head Judge must not be under the influence of drugs or alcohol while officiating. The Head Judge should never engage in any activity that may damage the reputation and professionalism of U-FLI and of the clubs affiliated with U-FLI.

## Section 4. Equipment

### 4.1 Jumps

The host club will provide eight Flyball jumps (four jumps per racing lane). Flyball jumps must meet the following specifications:

- Jump slats and bases must be made from plywood, Sintra (or equivalent), or other approved material. U-FLI strongly encourages the use of Sintra (or equivalent) material for all 1" slats. Plywood may not be used for 1" slats. All sharp edges must be removed.
- Bases and side stanchions may be up to  $\frac{3}{4}$ " thick, all other slats can be no thicker than  $\frac{1}{2}$ ". Jump slats and bases must be white in color.
- Jump bases must be no more than 6" high. Host clubs shall provide jump slats that will allow the jumps to be raised to a height of 12" with the topmost slat always being 1" exclusive of a 6" jump height. A  $\frac{1}{4}$ " tolerance is allowed for jump heights. U-FLI recommends clubs have a supply of spare 2" and 1" slats and at least one spare jump base should they become damaged during competition. Logos and/or lettering are permitted but must first be approved by U-FLI.
- Jump stanchions must be between 24" and 36" high. They may be any color. Logos and/or lettering are permitted.
- Jump stanchions must be 24" apart.

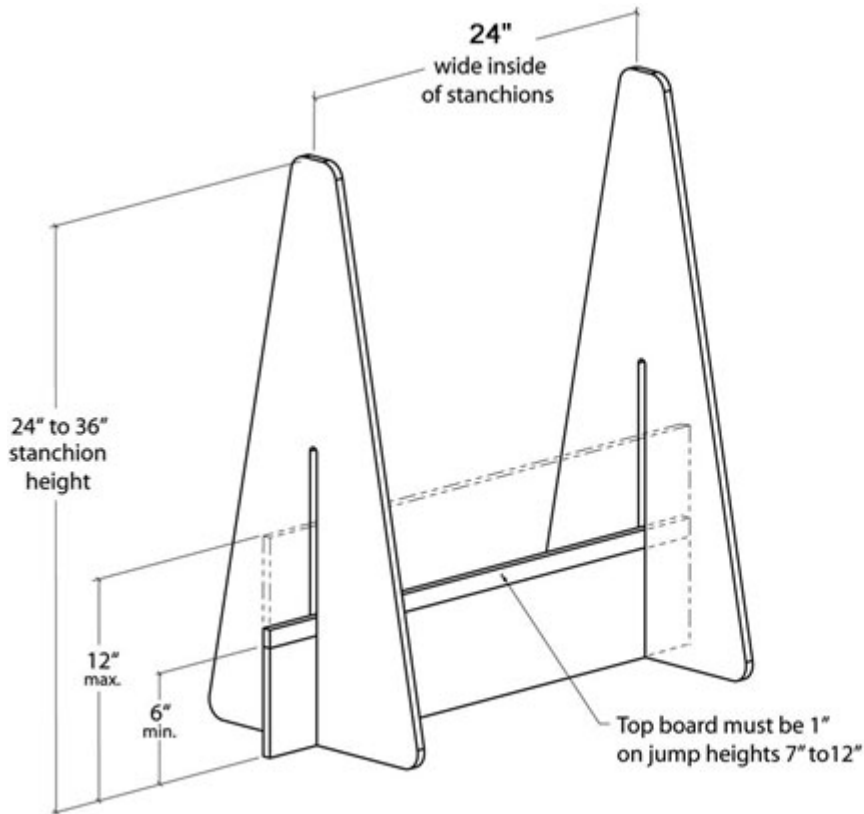

**Flyball Jump**  
Fig. #4.1  
7" to 12" Height Range

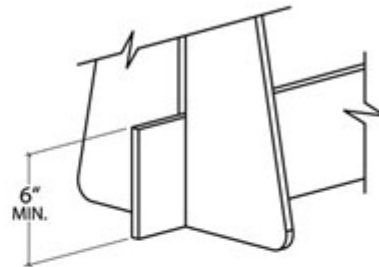

**Flyball Jump - Alt. Hgt**  
Fig. #1.1a  
1" top board is not required when jumping 6"

## 4.2 Flyball Boxes

Each club is responsible for providing its own Flyball box. The Flyball box must meet the following specifications:

- Boxes must have a mechanical release system. Electrical or hydraulic devices are not allowed.
- Boxes may be decorated and/or painted any color. Logos and/or lettering are permitted.
- When triggered, the Flyball box must eject the ball. The ball must be able to travel at least 24" from all points of release toward the Start/Finish line.
- The box cannot exceed 30" in width, nor exceed 20" in height. Mats or grabbing devices to hold the box in place cannot raise the box more than 1/2" higher than the maximum allowed height. The body of the box cannot exceed 30" in depth, excluding the base upon which the box loader stands. The box shall not exceed these dimensions at any time during racing, excluding carrying handles and stakeholders.

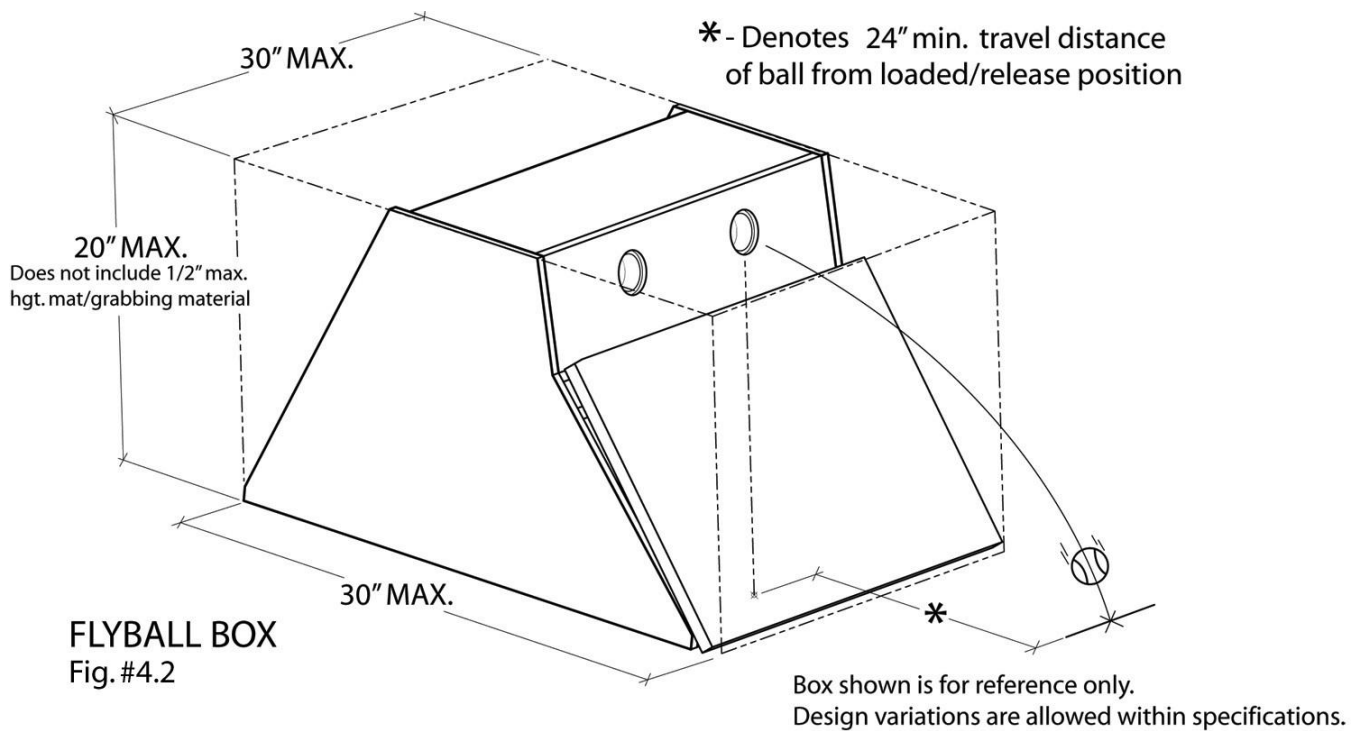

## 4.3 Balls

Each club shall provide its own supply of balls. Approved balls may be of any size, color or design and must bounce and roll. The ball must be able to travel 24" when thrown by the box.

#### 4.4 Backstop

The host club shall provide a backstop at the box end of each racing lane. The purpose of the backstop is to prevent missed balls from rolling too far out of play. A backstop shall consist of three sides and must meet the following specifications:

- The minimum panel side height is 24", with a maximum height of 36".
- Each side shall be approximately 8' in length.
- Backstops can have logos and may be any color.
- Material should be suitable for preventing balls from rolling too far out of play.

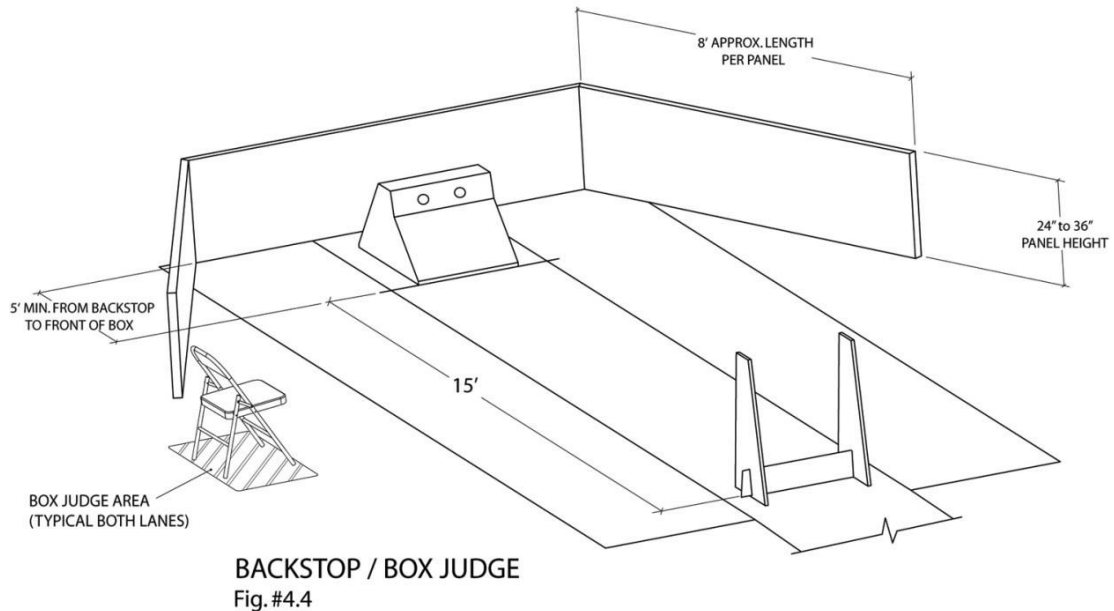

#### 4.5 Digital Timing System (DTS)

U-FLI shall provide a Digital Timing System (DTS) for use at U-FLI sanctioned events. U-FLI will provide the DTS at no cost when the tournament weekend consists of twelve or more teams in the Standard and Variety Classes combined. When entries are less than twelve teams per weekend in the Standard and Variety Classes combined, teams requesting the DTS shall be responsible for the shipping fee to their event.

Host clubs may request additional sets of DTS subject to approval and availability.

The Digital Timing System (DTS) will be used for all classes of competition, except for Pre-Flight. In the event the Digital Timing System (DTS) cannot be used, and manual timing must be used, no record times or rankings will be recorded.

#### 4.6 Collars

Unacceptable collars for all dogs attending U-FLI events will include:

- Electronic collars
- Dummy electronic collars
- Pinch, pressure, or prong collars



Choke chains, halter-type collars and muzzles will be allowed on the grounds, but they need to be removed immediately upon entering the ring.

All leashes and leash tabs, regardless of length, must be removed prior to the dog running the course, including warm-ups.

Dangling tags may be deemed unsafe. Any tags deemed as unsafe must be removed or secured tightly to the collar.

## Section 5. The Flyball Ring

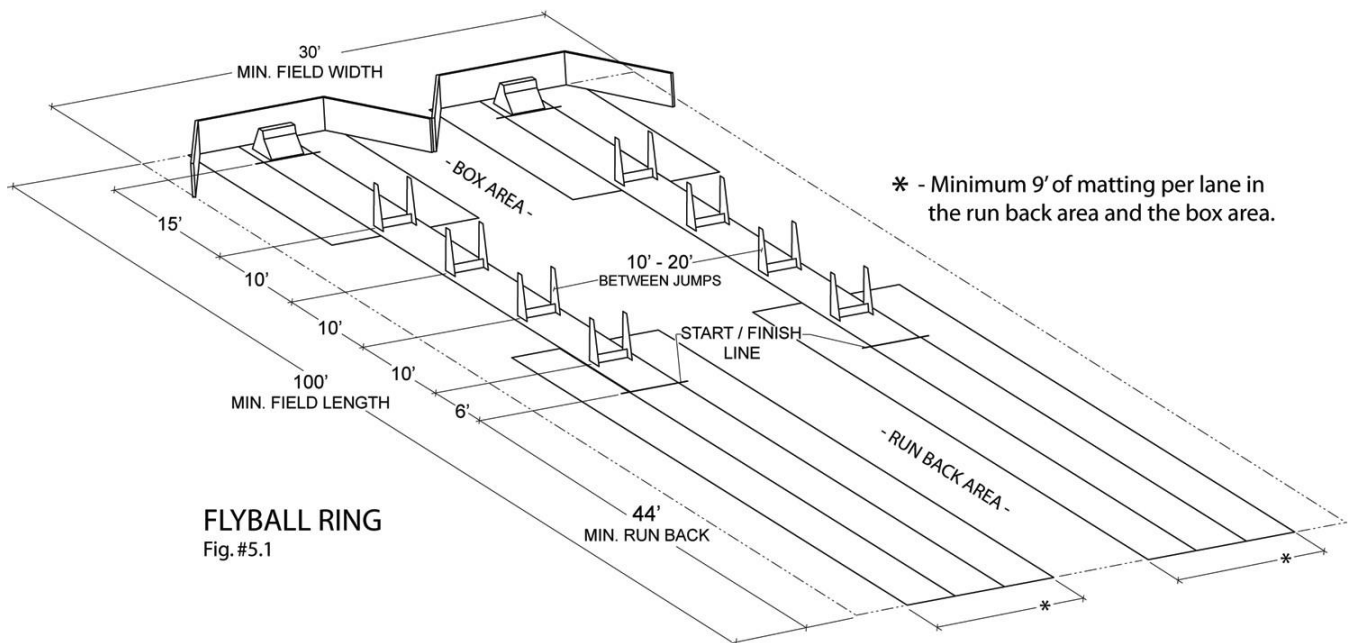

### 5.1 Ring Size

The minimum ring size shall be 30' X 100'. Any exceptions must be approved by U-FLI prior to tournament sanctioning. Racing lanes shall be a minimum of 10' apart and a maximum of 20' apart as measured from the inside edges of the jump stanchions.

### 5.2 Footing

Host clubs must supply a non-slip surface for racing. U-FLI recommends ribbed anti-fatigue matting specifically produced for flyball.

When racing is to be held indoors or on a hard surface such as concrete or wood, the host club shall provide adequate matting to cover the surface. Matting shall cover the following minimum areas:

- Each racing lane shall have a minimum 9' wide matted area, centered on the racing lane, from the jump closest to the Flyball Box extending to the back edge of the Backstops.
- Each racing lane shall have a minimum 3' wide matted area, centered on the racing lane, from the jump closest to the Start/Finish line to the jump closest to the Flyball box.
- Each racing lane shall have a minimum 9' wide matted area, centered on the racing lane, from the jump closest to the Start/Finish line extending back into the runback area a



minimum of 44'.

- All matting must be secured on both edges of the mat throughout its entire length.

When racing is to be held on a natural surface, throughout the duration of the event, clubs must ensure that the entire racing ring is free from apparent contaminants, is reasonably level, and is free from holes, ruts, and obstacles.

### **5.3 Start/Finish Line**

The Start/Finish Line spans the width of the flyball ring with no vertical limit. The Start/Finish Line shall be clearly marked across the width of each Racing Lane. The Start/Finish line will always be a contrasting color against the running surface.

### **5.4 Jump Placement**

Four Flyball jumps are required in each racing lane. Each jump is placed in line, 10' apart from each other, with the first jump placed 6' after the Start/Finish line.

Jump placement shall be marked in the ring so that the jump can be easily replaced should it be knocked out of position.

### **5.5 Flyball Box Placement**

A Box Line shall be marked across the width of each racing lane. The Box Line shall be 51' from the Start/Finish line. Flyball Boxes must be positioned with no part extending beyond the Box Line towards the Start/Finish line.

### **5.6 Backstop Placement**

The center panel of the backstops shall be placed a minimum of 5' from the Box Line.

### **5.7 Digital Timing System Placement**

The Digital Timing System (DTS) sensor panels should be placed such that the entering sensors are placed directly on the Start/Finish line with the exiting sensors placed closest to the Box Line. The sensor panels should be placed a minimum of 36" apart but no more than 48" apart. The light tree shall be placed directly between the racing lanes, located between the Start/Finish line and first jump, and shall not create an obstruction.

### **5.8 Markings**

- When racing on an artificial surface, a measuring tape shall be placed in each Racing Lane from the Start/Finish line extending to the end of the Runback area. The tape shall be placed to the right of the center of the Racing Lane. The measuring tape shall indicate feet and inches. The measuring tape shall be secured using clear tape covering it from the Start/Finish line to the end of the Runback.
- When racing on a natural surface, footage markings shall be indicated in each Racing Lane. Footage markers shall start at the Start/Finish line and extend to the end of the Runback. Footage markers will be spaced in no greater than 1' increments. The host club should make every effort to ensure that footage markers are always clearly visible.
- U-FLI suggests the first 5' of runback away from the Start/Finish Line shall have markers in 1' increments. These markings may be any contrasting color to the running surface.
- It is necessary to establish clear physical boundaries of the racing ring for safety reasons. U-FLI suggests using ring gates (or a similar fencing). When space allows, establishing clear physical boundaries that are larger than the ring, allows for flexibility and additional safety.

## 5.9 Box Judges

Seating for Box Judges should be located outside of the racing lane between the Box Line and the jump closest to it. The Box Judge should not be in a position that hinders access to and from the ring, nor should they impede dogs that may be competing in the heat.

## 5.10 Line Judges

The Line Judge should be positioned so both they and the Pass Caller have a clear, unobstructed view of the Start/Finish line. Additional tournament help/staff positioned with the Line Judge shall be on the side opposite of the Start/Finish line toward the Runback.

## 5.11 Timing Judges

In the case of manual timing, the Timing Judge shall be positioned in line with the Start/Finish Line.

## 5.12 Scoring Table

Whenever possible the Scoring Table shall be placed outside of the Flyball Ring adjacent to the Runback. The Scoring Table should have an unobstructed view of the Digital Timing System (DTS) and the Head Judge. The table shall be positioned at such a distance that allows cables from the Digital Timing System (DTS) to reach the table without causing a safety hazard for the participants.

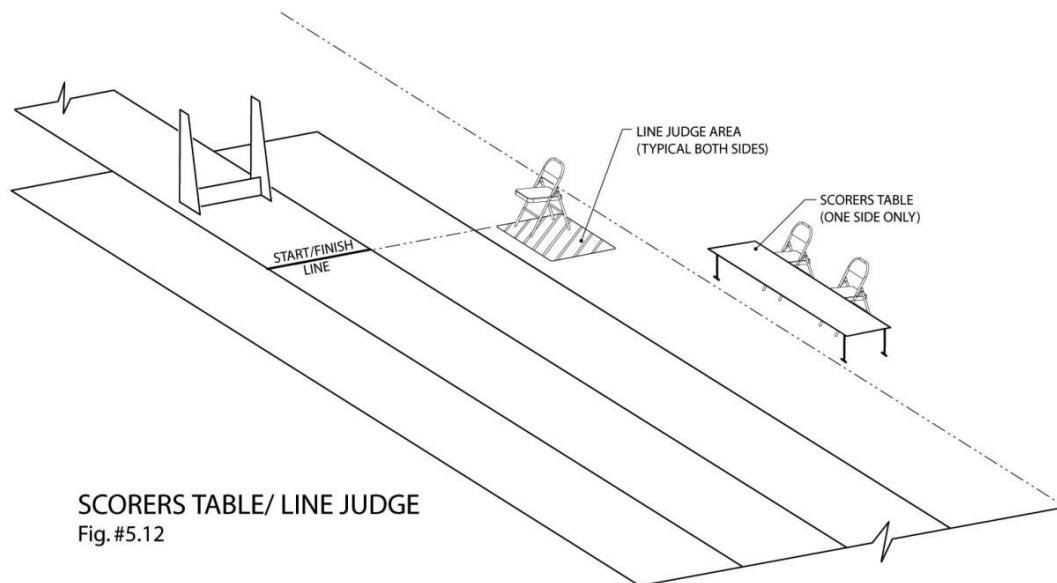

## 5.13 Multiple Rings

When a tournament has more than one ring, every effort should be made to keep the rings uniform in appearance and setup to provide consistent racing conditions in all rings.

## Section 6. Measuring and Jump Heights

All eligible dogs shall have a recorded jump height of 12" until they have been measured at a U-FLI sanctioned tournament. Dogs designated as a height dog, desiring to jump less than 12" shall be measured by a U-FLI judge at a U-FLI tournament. Once a measurement is recorded with U-FLI, the dog need not be measured again. This measurement shall be recorded in the U-FLI Database and shall supersede any previously recorded measurement as the dogs jump height. A dog will only be allowed to be measured once at any U-FLI sanctioned tournament.

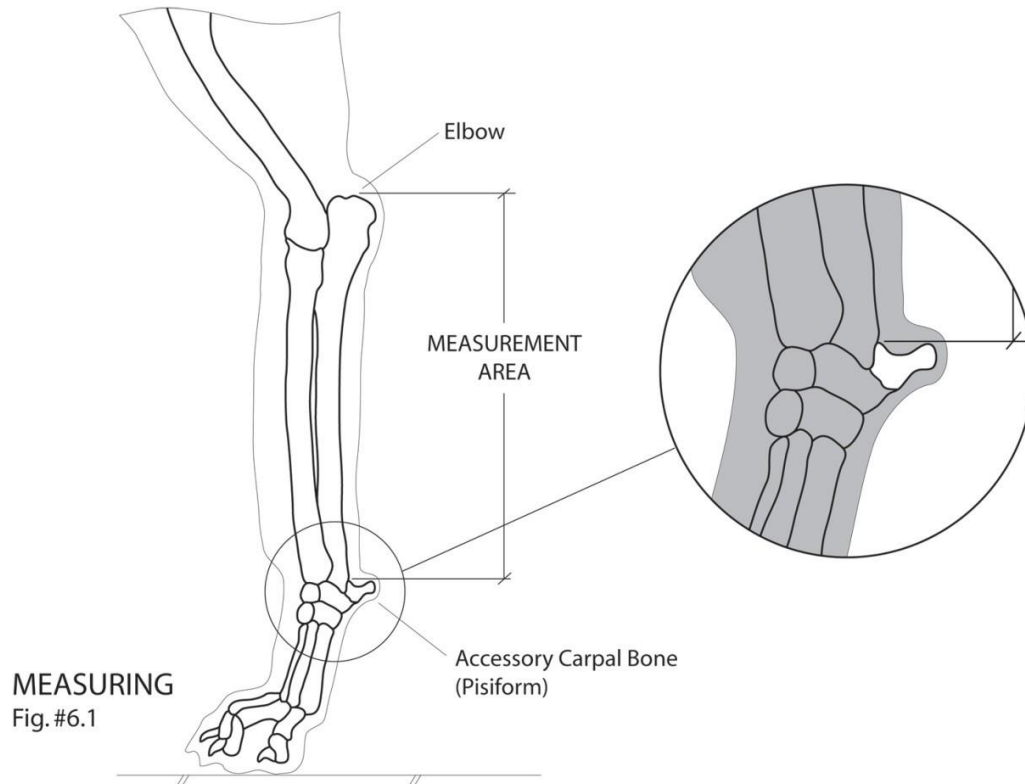

Dogs will be measured from the point of the elbow to the Accessory Carpal Bone (Pisiform), the bony protrusion just above the stop or carpal pad. The following chart will determine the jump height:

Elbow to Accessory Carpal Bone Measurement	Jump Height
Up to 4.5"	6"
Over 4.5" up to 5"	7"
Over 5" up to 5.5"	8"
Over 5.5" up to 6"	9"
Over 6" up to 6.5"	10"
Over 6.5" up to 7"	11"
Over 7"	12"





The dog with the shortest recorded jump height will determine the minimum jump height for the entire team during each heat.

Measuring will be done by the Head Judge using a Patented U-FLI Measuring Device and will be recorded on the measuring report sheet. Measuring is to be done in a public area. A dog that will not cooperate for measurement will be deemed unmeasurable and have its jump height set for 12".

Aggression during measuring will not be tolerated and may cause the dog to be excused from the event.

The Head Judge's decision is final. Measurements will be recorded on the Jump Height Recording sheet and posted in a public area during the event.



## Section 7. Points, Titles and Awards

### 7.1 Points

Dogs will receive points toward individual U-FLI titles based on the team's time. Each dog listed as participating in a heat will be awarded points. No points will be awarded for heats in which a team received a forfeit, no finish, interference, fouling, or breakout. Teams that receive an estimated time will be awarded U-FLI points.

#### Teams times

19.999 seconds and under  
20 seconds up to 24.999 seconds  
25 seconds up to 29.999 seconds  
30 seconds up to 35.000 seconds

#### Points earned

30 points per heat  
25 points per heat  
15 points per heat  
10 points per heat

Each of the dogs on a winning team in a heat will receive an additional 5 bonus points for that heat. Exhibition or Pickup Teams will not receive bonus points.

### 7.2 Individual Titles and Awards

#### Award Pins

Title	Points
Top Flight	100
TF-I	500
TF-II	750
TF-III	1,000
Top Flight Executive	2,500
TFE-I	4,000
TFE II	5,500
TFE-III	7,000
Top Flight Premier	9,500
TFP-I	12,000
TFP-II	14,500
TFP-III	17,500
Top Flight First Class	20,500
TFFC-I	24,000
TFFC-II	27,500
TFFC-III	31,000

Title	Points
Top Flight World Class	35,500
TFWC-I	40,000
TFWC-II	44,500
TFWC-III	49,000
Top Flight X-treme	54,500
TFX-I	60,000
TFX-II	65,500
TFX-III	71,000
Top Flight Ultimate	77,500
TFU-I	84,000
TFU-II	90,500
TFU-III	97,000

#### Milestone Plaques

Title	Points
Top Flight Expert	20,000
Top Flight Ace	35,000
Top Flight Champion	50,000
Top Flight Specialist	75,000
Top Flight Elite	100,000



### **7.3 Single and Pairs Awards**

A singles or pairs dog that has participated in the Singles or Pairs class in at least ten (10) separate U-FLI sanctioned tournaments on ten (10) separate weekends and has successfully completed at least one heat at each of those tournaments will be awarded a Singles or Pairs pin and awarded the title of Single Dog Racer or Pairs Dog Racer.

A singles or pairs dog that has participated in the Singles or Pairs class in at least twenty (20) separate U-FLI sanctioned tournaments on twenty (20) separate weekends and has successfully completed at least one heat at each of those tournaments will be awarded a Singles or Pairs Level I bar and awarded the title of Single Dog Racer I or Pairs Dog Racer I.

A singles or pairs dog that has participated in the Singles or Pairs class in at least thirty (30) separate U-FLI sanctioned tournaments on thirty (30) separate weekends and has successfully completed at least one heat at each of those tournaments will be awarded a Singles or Pairs Level II bar and awarded the title of Single Dog Racer II or Pairs Dog Racer II.

A singles or pairs dog that has participated in the Singles or Pairs class in at least forty (40) separate U-FLI sanctioned tournaments on forty (40) separate weekends and has successfully completed at least one heat at each of those tournaments will be awarded a Singles or Pairs Level III bar and awarded the title of Single Dog Racer III or Pairs Dog Racer III.

### **7.4 Junior Award of Merit**

U-FLI is proud to recognize and reward the efforts of participants who are under 18 years of age through the Junior "Award of Merit" Program. Clubs are encouraged to submit the Junior Award of Merit Verification form to U-FLI for each of its qualified junior participants. Once the Junior Award of Merit verification form has been received and the participant's accomplishments verified, U-FLI will issue the appropriate Junior Award of Merit.

- Novice: A junior participant who has participated in one (1) tournament shall be awarded the Novice Junior Award of Merit Certificate.
- Intermediate: A junior participant who has been awarded the Novice Junior Award of Merit Certificate and has participated in an additional five (5) U-FLI sanctioned tournaments on five separate weekends shall be awarded the Intermediate Junior Award of Merit Pin.
- Advanced: A junior participant who has been awarded the Intermediate Junior Award of Merit Pin and has participated in an additional five (5) U-FLI sanctioned tournaments on five separate weekends shall be awarded the Advanced Junior Award of Merit Plaque.

### **7.5 Affinity Award**

The Affinity Award Program allows competitors to combine points earned from any flyball sanctioning organization worldwide with U-FLI Points to earn titles.

#### **Qualifications for Affinity Titles:**

- Including your U-FLI points, earn a minimum of 20,000 combined points from any flyball sanctioning organization worldwide to be a recipient of the Affinity Award Program.
- Register as a member of the Affinity Award Program (online) for a one-time fee per participant (not per dog). See Schedule of Fees - Appendix A.
- Submit your completed Affinity Award Form, summarizing all sanctioned flyball organization earned points to [affinity@u-fli.com](mailto:affinity@u-fli.com).
- Run in a minimum of two (2) U-FLI tournaments, over two (2) separate weekends, over the course of one (1) year.



## Affinity Program Titles

Points	Program Title
20,000	Affinity Launch
35,000	Affinity Orbit
50,000	Affinity Star
75,000	Affinity Comet
100,000	Affinity Eclipse
150,000	Affinity Galaxy
200,000	Affinity Super Nova
250,000	Affinity Quasar
300,000	Affinity Mega Star

- All awards will be issued quarterly each year.
- Certificates will be issued and mailed at no charge to the participant.
- Optional pins and plaques for each title may be ordered separately and paid for by the participant. See Schedule of Fees - Appendix A.

## 7.6 U-FLI Records

U-FLI recognizes and records U-FLI Records in the Standard class of competition. The U-FLI Record Validation process must be followed:

- The event is sanctioned by U-FLI.
- The DTS was fully operational and used during the heat.
- The U-FLI Record Validation Process is followed immediately after the completion of the heat and prior to another heat or race beginning.
- The U-FLI Record Validation Form is approved by the U-FLI Validation Committee.

Video from all approved Standard Class U-FLI Record heats will be posted to the U-FLI website.

Any run time that is faster than the current U-FLI record will not be posted to the website unless a video recording is submitted, and all U-FLI record procedures are followed and validated. In instances when no recording is submitted for validation, the U-FLI recorded time will be changed to .001 slower than the current recorded U-FLI record time.

### Validation Procedure:

Team Obligation:

A recording of the race must be taken and meet the following specifications:

- The camera must be positioned such that the Validation Committee has a clear view of the start/finish line and can make a confident determination about the validity of the passes.
- The recording must be of good quality. Poor quality recordings that do not provide a clear view of the heat will not be accepted.
- The video must show a continuous, unedited recording of the heat. It must show the entire heat and the time as displayed on the DTS (score table time or display). At a minimum, the green start light from the DTS tree must be in view during the entire heat.



Immediately After the Record Heat:

- The record time will display immediately on the DTS. The team and the judge will be made aware immediately.
- The recording should be turned over immediately to the judge/U-FLI rep/or board member (if present).
- Recording will be reviewed immediately if possible. If not possible, the recording will be emailed to U-FLI at [admin@u-fli.com](mailto:admin@u-fli.com). Recording cannot be password protected.

The Head Judge must:

- Stop racing, once the heat is over, to complete the validation process.
- Verify with all ring judges that there are no outstanding infractions.
- Copy the time from the DTS onto the U-FLI Record Validation Form.
- Ensure that the proper jump height was used by comparing the team's time sheet and/or the Height Measurements recording sheet for that event to the actual set jump height for the heat.
- Verify that the lane has been measured using a measuring tape (steel tape preferred) and that at least 51' in length, measure from the Start/Finish Line to the front-most edge of the flyball box was obtained. The flyball box must be no less than 51' from the Start/Finish Line.
- Witness that the team's recording of the heat is immediately given to the U-FLI Representative.
- Complete and sign the U-FLI Record Validation Form and submit it immediately to the U-FLI Representative.

The U-FLI Representative will:

- Be in control of the recording at all times.
- Send a copy of the recording to the Validating Committee.
- If two or more independent Validation Committee members are present at the event, the recording can be sent directly.

The U-FLI Validation Committee will:

- Review and validate the recording and the signed U-FLI Record Validation Form.
- Review each pass. Early passes (i.e., any part of the incoming dog passes the plane of the start sensors before any part of the returning dog passes the plane of the return sensors) whether indicated by the DTS or not will be a disqualification.
- Validate each dog has carried the ball completely across the start/finish line.
- Validate no part of the handler or any object that the handler is carrying crosses the plane of the start/finish line.
- Verify that each participating dog has a valid RUN and that the Club and all participating dogs and handlers are in good standing with U-FLI.
- If all U-FLI Record Criteria have been met, approve the U-FLI Record Validation Form, and recognize that heat as a U-FLI Record and post the recording of the heat on the U-FLI website.
- If the record cannot be validated for any reason, convert the time of the run to a "no time" (NT) on all U-FLI records as well as the U-FLI website. Wins, losses and placements shall not be changed.

If two or more independent U-FLI Validation Committee members are present at the event in which a record time is recorded, and appropriate equipment for viewing the submitted recording are available, the Validation Committee members may view the recording, and all submitted documents at the conclusion of the event and approve the U-FLI Record Time on-site.

The Validating Committee shall be independent of the U-FLI Record applicant team.



## **Section 8. Sanctioned Events**

### **8.1 Sanctioning**

U-FLI registered clubs may apply for sanctioning of U-FLI tournaments and events pursuant to policies set forth by U-FLI. Registered clubs in good standing with U-FLI wishing to host a sanctioned event must apply for sanctioning via the U-FLI website or in writing a minimum of 60 days in advance of the event start date. Any request for waiver of the 60-day period must be submitted in writing to U-FLI.

All clubs hosting a U-FLI sanctioned event will be required to provide a certificate of "Additional Insured" to U-FLI prior to the event.

In order to receive U-FLI points, the Standard class must have a minimum of four (4) teams entered, Variety class must have a minimum of three (3) teams entered, Pairs, Singles and Pre-Flight classes have no minimum. The Standard class must be offered at all U-FLI sanctioned tournaments.

### **8.2 Announcement of Tournaments**

All approved tournaments shall be listed on the U-FLI website.

To be fair to all participants, host clubs may not begin taking entries until the tournament is approved and listed on the U-FLI website.

### **8.3 Types of Tournaments - Limiting Entries**

Clubs may specify whether entries for each class will be unlimited or limited. In the case of a limited class, the minimum allowed limit for the Standard Class is 12, Variety Class is 6, and Pairs, Singles, and Pre-Flight Classes are 5 teams each class.

When entries received exceed the class limit, entries will be accepted in the order received. Once sorted by date of receipt, host clubs will accept 1 team from each of the clubs entered. If after accepting one team from each entered club, the class limit still has not been reached, a second team from each requesting club will be accepted. This process will be repeated until all available openings have been filled. Once the host club has determined how many entries per club will be accepted, the host club shall notify each entered club. Clubs that did not have all their team entries accepted will have 48 hours to specify which teams will fill the allotted slots and verify the seed times.

### **8.4 Seeding**

After the tournament closing date, the Tournament Director will divide entries for each class into divisions. When determining division breaks, the Tournament Director should take into consideration the format to be used and the number of races to be given to each team. As entries allow, divisions should be setup to provide fair and competitive racing. The Tournament Director is responsible for submitting the proposed seeding and format to U-FLI for approval no later than 14 days prior to the tournament.

Where submitted seed times are the same, teams will be listed in alphabetical order. A division will have a minimum of three teams.



## 8.5 Racing Formats

Acceptable racing formats include round robin or round robin combined with double or single elimination rounds. Racing formats and scoring will be approved by U-FLI for each tournament.

In the case of round robin formats, the first and second seed teams shall always have the last race of their division.

### Suggested scoring:

Format	Scoring	Ties
Round Robin 3/3, 4/4, or 5/5	1 point for each heat won. ½ point to each team for tied heats. Optional: 1 bonus point each race won.	Two-way ties shall be decided by the result of head-to-head racing. If still tied, the fastest time from the head-to-head race will decide. Three-way ties or more shall be decided by the fastest time in the tournament.
Round Robin 3/5	1 point for each race won. In the event of no winner after 5 heats, no points will be awarded to either team.	Two-way ties shall be decided by the result of head-to-head racing. If still tied, the fastest time from the head-to-head race will decide. Three-way ties or more shall be decided by the fastest time in the tournament.
Round Robin into Elimination	Round Robin scoring shall be as states above. The results of the Round Robin will determine seeding for the Elimination. The placement from the round robin and the placement from the elimination will be added to together to determine final placement.	Ties for overall placement should be broken by the fastest overall tournament time.  Ties for <i>heats</i> in an elimination format: Ties will be rerun if the winner of the race is undecided.

## 8.6 Schedules

After seeding and format have been submitted to U-FLI by the Tournament Director and approved, U-FLI will generate and deliver a suggested racing schedule to the Tournament Director. Any changes to the schedule must be approved by U-FLI prior to the event.

If the host club prefers, they may generate their own schedule. When the tournament entries close the host club must alert the U-FLI Sanctioning department of their intention to create their own schedule. U-FLI will work with the host club and supply the tools and support to create the schedule to meet U-FLI standards. Host club generated schedules must be submitted two (2) weeks prior to the tournament date for approval.

## 8.7 Prizes and Awards

The host club is responsible for determination of event awards.

Title award plaques will be mailed to Tournament Directors of events throughout the year based on timing and shipping costs.



## **8.8 *Tournament Director Duties and Responsibilities***

The Tournament Director is designated by the host club and shall:

- Submit tournament seeding and format to U-FLI for review and approval.
- Specify a measuring and box check time.
- Work with U-FLI Sanctioning to approve the final schedule.
- Oversee the event.
- Coordinate with the U-FLI Representative at the event.
- Submit final paperwork and tournament fees to U-FLI within a timely manner.





## Section 9. Judges and Scorekeepers

During sanctioned U-FLI events, there shall be one U-FLI approved Head Judge who will oversee and have final authority on all activities and determinations within the racing ring. There will also be two Line Judges, two Box Judges, and one or more Scorekeeper(s) who will provide assistance to the Head Judge. These individuals should have a good understanding of Flyball and of U-FLI Rules.

Only individuals who are listed on the U-FLI Approved Judges list shall be permitted to Head Judge at a U-FLI sanctioned event.

The Head Judge shall be responsible for measuring dogs prior to the start of competition, verifying the ring, and testing the Flyball boxes. The Head Judge shall reserve the right to appoint another U-FLI approved Head Judge, if available, or another knowledgeable and experienced individual to test the Flyball boxes prior to the start of racing.

The Head Judge, Line Judges and Box Judges shall signal infractions. The Head Judge alone shall make the final determination regarding infractions. The Head Judge's decision shall be final.

The host club should make every effort to provide a relief Head Judge for each ring of a U-FLI sanctioned event. When a relief judge is not available, the host club should ensure that adequate breaks are provided for the Head Judge.

Judges shall be fair and impartial. Line and Box Judges should always defer questions regarding a ruling to the Head Judge.

### 9.1 Duties and Responsibilities - Head Judge

The Head Judge shall:

- Be positioned in the Runback between the two racing lanes with a clear view of both Racing Lanes. The Head Judge must be in a location that will not interfere with either of the competing teams.
- Start and stop each heat.
- Determine the outcome of each heat by awarding a win, loss, no finish, tie, interference, etc.
- Indicate when an infraction occurs and when it is necessary to rerun a dog.
- Stop the heat when necessary by indicating with a whistle. Reasons for stopping a heat may include, but are not limited to interference, box malfunction, fouling in the ring, aggression, or other safety hazards.
- Complete and submit the Judges Report.

#### **Becoming a U-FLI Head Judge**

It is the goal of U-FLI to provide a pool of highly trained judges who are consistent with each other in interpreting the rules and will present a professional image for the U-FLI organization and the events they oversee. Parties interested in becoming a U-FLI Head Judge, should contact the Judges Coordinator. The following steps are required:

- Print, read and study a copy of the U-FLI rules.
- Obtain Sponsorship from a U-FLI Head Judge or a U-FLI Board Member.
- Submit an application to U-FLI.
- Complete a minimum of one full day each of box judging, line judging and scorekeeping assignments, with any U-FLI Head Judge.
- Complete a minimum of four (4) Apprentice Judging assignments on different weekends with two (2) different Training Judges.
- Pass the written exam.
- Submit review application to the U-FLI Judges Coordinator.
- The U-FLI Board of Directors will review the application and it will either be approved, or the



- applicant will be informed as to what further requirements must be met.
- After approval, all new judges will serve a probationary period requiring five (5) judging assignments over five (5) different weekends within an 18-month period.
  - After meeting the probationary requirements, judges may apply for Head Judge status by submitting an application to the U-FLI Judges Coordinator.
  - The U-FLI Board of Directors will either approve the application or the applicant will be informed as to what further requirements must be met.

All judges must be a minimum of 18 years of age and Participants in good standing with U-FLI.

## **9.2 Duties and Responsibilities - Line Judge**

The Line Judge shall:

- Record which dogs are running in each heat.
- Verify jump heights are set correctly based on timesheet information.
- Notify the Head Judge when a Pickup or Exhibition Team is racing.
- Indicate when a dog in their lane must rerun due to a rule infraction by raising their flag over their head.
- Record the outcome of each heat - win, loss, etc. as indicated by the Head Judge.
- Record the time of each heat.

## **9.3 Duties and Responsibilities - Box Judge**

The Box Judge shall:

- Indicate when a dog in their lane must rerun due to a rule infraction by raising their flag over their head.

## **9.4 Duties and Responsibilities – Scorekeeper**

The Scorekeeper shall:

- Ensure that that record keeping is kept current.
- Ensure that timesheet information has been recorded correctly.
- Notify the Head Judge of any breakouts during the heat.
- Record race results for posting by the host club.
- Notify the Head Judge of any ring delays.
- Alert the Head Judge to any forfeiting teams and any team ineligible for tournament placement.
- The Scorekeeper will indicate on the timesheet when a team is racing against an Exhibition or Pickup Team and notify the Head Judge prior to the team racing.



## **Section 10. U-FLI Champions**

### ***10.1 Overview***

Each year U-FLI will acknowledge a U-FLI Champion in multiple time divisions. These Champions will be determined from the results of an annual Tournament of Champions. To compete in the Annual Championship Tournament, clubs will have to meet eligibility requirements, which are reviewed, updated, and published each year on the U-FLI website. Please refer to the website for the current year's guidelines.



## Appendix A. Schedule of Fees

Below is the U-FLI fee schedule. If a form's instructions indicate that you must pay a fee, use the table below to find the correct fee. Submission of incorrect fees may cause delays in processing and/or cause late charges.

All fees are payable in U.S. Dollars.

Club Registration	\$20	Per Club
Dog Registration – Race Utility Number (RUN)	\$10	Per Dog
Tournament Fees (to be paid by host club):		
Standard & Variety 1-Day Event	\$20	Per Team Entered
Standard & Variety 1 Event Over Multiple Days	\$30	Per Team Entered
Pairs	\$10	Per Team Entered
Singles	\$5	Per Team Entered
Pre-Flight Singles	\$5	Per Team Entered
<b>Note:</b> A minimum fee of \$250 will be assessed per Event Weekend		
Late Charges:		
Fees and Tournament Documents received after 15 days	\$50	Per Tournament
Fees and Tournament Documents received after 30 days	\$100	Per Tournament
Fees and Tournament Documents received after 45 Days	\$250	Per Tournament
DTS Shipping Delay:		
Second Day after required shipping date	\$150	
Second Day after required shipping date affecting next Tournament	\$150	+ Express Shipping Fee
Returned Checks	\$35	Each
Cancellation of Tournament after DTS ships	\$250	
Copy of Timesheets	\$5	Per Team, per Tournament
Printed Rule Book	\$10	+ Shipping & Handling
Replacement of Pins (shipping & handling included)	\$10	Per Pin
Replacement of Plaques (shipping & handling included)	\$50	Per Plaque
Affinity Award Program:		
Membership	\$25	Per Participant
Pins (shipping & handling included)	\$5	Per Pin
Plaques (shipping & handling included)	\$50	Per Plaque
<b>Note:</b> Additional charges may apply if shipped out of US		



## Appendix B. Contact List

Contact information for U-FLI customer service is listed below.

Phone number		702-527-UFLI (8354)
Address		United Flyball League International PMB 169 4132 South Rainbow Blvd. Las Vegas, NV 89103
General information		admin@u-fli.com
Championship information		championship@u-fli.com



## **Appendix C. Official Forms**

### ***Pre-flight Entry Form***

To be completed by host club once entries are received and schedule has been completed. Pre-flight handlers must sign form.

### ***Singles Tournament Entry Form***

### ***Pairs Tournament Entry Form***

### ***Team Tournament Entry Form***

### ***Singles Time Sheet***

### ***Pairs Time Sheet***

### ***Team Time Sheet***

### ***Novice Junior Award of Merit Verification Form***

### ***Intermediate Junior Award of Merit Verification Form***

### ***Advanced Junior Award of Merit Verification Form***

### ***Height Measurements***

### ***Club Waiver***

### ***Excusal Form – Dog***

### ***Excusal Form – Participant***

### ***U-FLI Record Verification Form***

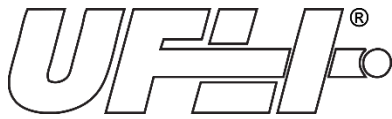

**PRE-FLIGHT ENTRY, ASSUMPTION OF RISK AND AGREEMENT TO INDEMNIFY AND HOLD HARMLESS**

**Event #:** \_\_\_\_\_ **Event Date:** \_\_\_\_\_ **Host Club:** \_\_\_\_\_

All events are held under the Rules and Regulations of United Flyball League International, Inc. (U-FLI™). U-FLI™, its officers, directors, agents, employees, and the host club assume no responsibility for any loss, accidents, theft, damage, death, or injury sustained by spectators, exhibitors, or handlers, or to any of their dogs or property.

I hereby agree to waive any claim, action, or lawsuit and further agree to indemnify and hold U-FLI™, its officers, directors, agents, employees, and the host club harmless from any claims, actions or lawsuits resulting from my and/or my Club's/Team's participation in this event.

I acknowledge that the current U-FLI™ Rules and Regulations have been made available to me, and that I am familiar with their contents. My signature indicates that I understand and agree to the above and to abide by all of the current U-FLI™ Rules and Regulations.

By signing this document, I acknowledge that I have the authority to sign and accept the conditions contained herein on behalf of myself, my Club, my Team, and any persons who may accompany myself and my Club and/or Team at this U-FLI™ event.

	<b>Dog's Name</b>	<b>RUN #</b>	<b>Breed</b>	<b>Race #s</b> (Left/Right)	<b>Signature</b> (Indicates that you have read and agree to the Waiver information above)
Ex.	Fido	99999	Mixed Breed	5 L / 65 R	
1					
2					
3					
4					
5					
6					
7					
8					
9					
10					
11					
12					
13					
14					
15					
16					
17					

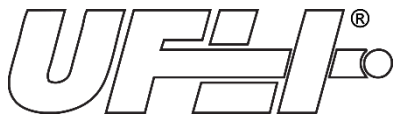

## SINGLES TOURNAMENT ENTRY FORM

U-FLI Tournament Information	U-FLI Singles Class Participant Information
<b>Tournament Name/Location:</b>	Participant Name:
<b>Tournament Date:</b>	Seed Time:
<b>Closing Date:</b>	Participant U-FLI Club# Affiliation (If applicable):
<b>Entry Fee:</b>	Address:
<b>Host Club:</b>	City:
<b>Check Payable &amp; Mail Payment To:</b>	State/Province:                      Zip/Postal Code:
<b>Tournament Director:</b>	Phone #:
	Email address:
	Dog's Name:
	U-FLI RUN #:
	Breed:

All events are held under the Rules and Regulations of United Flyball League International, Inc. (U-FLI™). U-FLI™, its officers, directors, agents, employees, and the host club assume no responsibility for any loss, accidents, theft, damage, death, or injury sustained by spectators, exhibitors, or handlers, or to any of their dogs or property.

I hereby agree to waive any claim, action, or lawsuit and further agree to indemnify and hold U-FLI™, its officers, directors, agents, employees, and the host club harmless from any claims, actions or lawsuits resulting from my and/or my club's/team's participation in this event.

I acknowledge that the current U-FLI™ Rules and Regulations have been made available to me, and that I am familiar with their contents. My signature indicates that I understand and agree to the above and to abide by all of the current U-FLI™ Rules and Regulations.

By signing this document, I acknowledge that I have the authority to sign and accept the conditions contained herein on behalf of myself, my Club, my Team, and any persons who may accompany myself and my club and/or team at this U-FLI™ event. Note: If the participant is under 18 years of age, a parent or guardian must sign.

Signature: \_\_\_\_\_ Date: \_\_\_\_\_



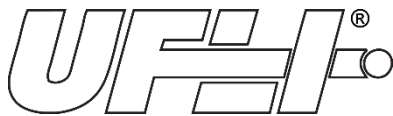

United Flyball League International, Inc.  
 PMB 169, 4132 South Rainbow Blvd.  
 Las Vegas, NV 89103  
 (702) 527-8354 / [www.u-fli.com](http://www.u-fli.com)

## PAIRS TOURNAMENT ENTRY FORM

U-FLI Tournament Information			
Tournament Name/Location:		Check Payable & Mail Payment To:	
Host Club:		Tournament Date:	Closing Date:
Entry Fee:		Tournament Director:	
U-FLI Pairs Racing Information			
Team Name:		Seed Time:	
U-FLI Pairs Class Participant Information			
Dog #1		Dog #2	
Participant Name:		Participant Name:	
Participant U-FLI Club# Affiliation (If applicable):		Participant U-FLI Club# Affiliation (If applicable):	
Address:		Address:	
City:		City:	
State/Province:		State/Province:	
Zip/Postal Code:		Zip/Postal Code:	
Phone #:		Phone #:	
Email Address:		Email Address:	
Dog's Name:		Dog's Name:	
U-FLI RUN #:		U-FLI RUN #:	
Breed:		Breed:	

All events are held under the Rules and Regulations of United Flyball League International, Inc. (U-FLI™). U-FLI™, its officers, directors, agents, employees, and the host club assume no responsibility for any loss, accidents, theft, damage, death, or injury sustained by spectators, exhibitors, or handlers, or to any of their dogs or property.

I hereby agree to waive any claim, action, or lawsuit and further agree to indemnify and hold U-FLI™, its officers, directors, agents, employees, and the host club harmless from any claims, actions or lawsuits resulting from my and/or my club's/team's participation in this event.

I acknowledge that the current U-FLI™ Rules and Regulations have been made available to me, and that I am familiar with their contents. My signature indicates that I understand and agree to the above and to abide by all of the current U-FLI™ Rules and Regulations.

By signing this document, I acknowledge that I have the authority to sign and accept the conditions contained herein on behalf of myself, my Club, my Team, and any persons who may accompany myself and my club and/or team at this U-FLI™ event.

Signature: \_\_\_\_\_ Date: \_\_\_\_\_

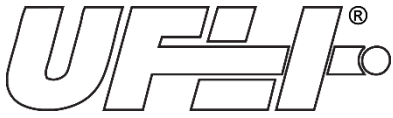

## TEAM TOURNAMENT ENTRY FORM

<b>U-FLI Tournament Information</b>	
Tournament Name/Location:	
Tournament Date:	Closing Date:
Entry Fee:	
Host Club:	
Check Payable/ Mail Payment To:	
Tournament Director:	
<b>U-FLI Club Information</b>	
U-FLI Club#:	
Club Name:	
Captain:	
Address:	
City:	
State/Province:	Zip/Postal Code:
Phone Number:	
Email Address:	

<b>Team Information</b>	
<b>1.</b>	Team Name:
	Class: <input type="checkbox"/> Standard <input type="checkbox"/> Variety <input type="checkbox"/> Pick-Up
	Seed Time:
<b>2.</b>	Team Name:
	Class: <input type="checkbox"/> Standard <input type="checkbox"/> Variety <input type="checkbox"/> Pick-Up
	Seed Time:
<b>3.</b>	Team Name:
	Class: <input type="checkbox"/> Standard <input type="checkbox"/> Variety <input type="checkbox"/> Pick-Up
	Seed Time:
<b>4.</b>	Team Name:
	Class: <input type="checkbox"/> Standard <input type="checkbox"/> Variety <input type="checkbox"/> Pick-Up
	Seed Time:
<b>5.</b>	Team Name:
	Class: <input type="checkbox"/> Standard <input type="checkbox"/> Variety <input type="checkbox"/> Pick-Up
	Seed Time:
<b>6.</b>	Team Name:
	Class: <input type="checkbox"/> Standard <input type="checkbox"/> Variety <input type="checkbox"/> Pick-Up
	Seed Time:

Comments/Additional Information: \_\_\_\_\_

All events are held under the Rules and Regulations of United Flyball League International, Inc. (U-FLI™). U-FLI™, its officers, directors, agents, employees, and the host club assume no responsibility for any loss, accidents, theft, damage, death, or injury sustained by spectators, exhibitors, or handlers, or to any of their dogs or property.

I hereby agree to waive any claim, action, or lawsuit and further agree to indemnify and hold U-FLI™, its officers, directors, agents, employees, and the host club harmless from any claims, actions or lawsuits resulting from my and/or my club's/team's participation in this event.

I acknowledge that the current U-FLI™ Rules and Regulations have been made available to me, and that I am familiar with their contents. My signature indicates that I understand and agree to the above and to abide by all of the current U-FLI™ Rules and Regulations.

By signing this document, I acknowledge that I have the authority to sign and accept the conditions contained herein on behalf of myself, my Club, my Team, and any persons who may accompany myself and my club and/or team at this U-FLI™ event.

Signature: \_\_\_\_\_ Date: \_\_\_\_\_

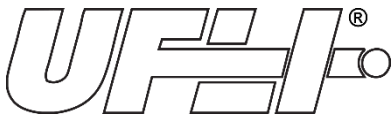

# SINGLES TIME SHEET

Event #: \_\_\_\_\_ Seed Time: \_\_\_\_\_

<b>Best Time:</b>	
-------------------	--

Host Club / Tournament Name: \_\_\_\_\_ Date: \_\_\_\_\_

Dog Information	
Dog's Name:	
RUN #:	
Breed:	
Club:	
Owner's Name	
Phone #:	

Race #	vs
Heat	Time
1	
2	
3	
4	

Race #	vs
Heat	Time
1	
2	
3	
4	

All events are held under the Rules and Regulations of United Flyball League International, Inc. (U-FLI™). U-FLI™, its officers, directors, agents, employees, and the host club assume no responsibility for any loss, accidents, theft, damage, death, or injury sustained by spectators, exhibitors, or handlers, or to any of their dogs or property.

I hereby agree to waive any claim, action, or lawsuit and further agree to indemnify and hold U-FLI™, its officers, directors, agents, employees, and the host club harmless from any claims, actions or lawsuits resulting from my and/or my club's/team's participation in this event.

I acknowledge that the current U-FLI™ Rules and Regulations have been made available to me, and that I am familiar with their contents. My signature indicates that I understand and agree to the above and to abide by all of the current U-FLI™ Rules and Regulations.

By signing this document, I acknowledge that I have the authority to sign and accept the conditions contained herein on behalf of myself, my Club, my Team, and any persons who may accompany myself and my club and/or team at this U-FLI™ event. Note: If the participant is under 18years of age, a parent or guardian must sign.

Signature: \_\_\_\_\_ Date: \_\_\_\_\_

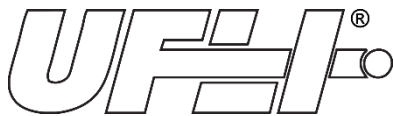

# PAIRS TIME SHEET

Event #: \_\_\_\_\_ Best Time: \_\_\_\_\_

Host Club / Tournament Name: \_\_\_\_\_ Date: \_\_\_\_\_

Seed Time: \_\_\_\_\_ Pairs Team Name: \_\_\_\_\_

Dog #1	
Dog's Name:	
RUN #:	
Breed:	
Club:	
Owner's Name:	
Phone #:	

Dog #2	
Dog's Name:	
RUN #:	
Breed:	
Club:	
Owner's Name:	
Phone #:	

Race #	vs	Time
Heat		
1		
2		
3		
4		

Race #	vs	Time
Heat		
1		
2		
3		
4		

All events are held under the Rules and Regulations of United Flyball League International, Inc. (U-FLI™). U-FLI™, its officers, directors, agents, employees, and the host club assume no responsibility for any loss, accidents, theft, damage, death, or injury sustained by spectators, exhibitors, or handlers, or to any of their dogs or property.

I hereby agree to waive any claim, action, or lawsuit and further agree to indemnify and hold U-FLI™, its officers, directors, agents, employees, and the host club harmless from any claims, actions or lawsuits resulting from my and/or my club's/team's participation in this event.

I acknowledge that the current U-FLI™ Rules and Regulations have been made available to me, and that I am familiar with their contents. My signature indicates that I understand and agree to the above and to abide by all of the current U-FLI™ Rules and Regulations.

By signing this document, I acknowledge that I have the authority to sign and accept the conditions contained herein on behalf of myself, my Club, my Team, and any persons who may accompany myself and my club and/or team at this U-FLI™ event. Note: If the participant is under 18years of age, a parent or guardian must sign.

Signature: \_\_\_\_\_ Date: \_\_\_\_\_

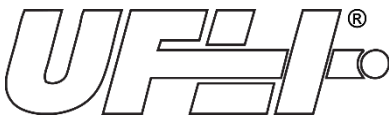

Division #:	
B/O Time:	
Best Time:	
Placement:	

## TEAM TIME SHEET

Event #: \_\_\_\_\_ Host Club / Tournament Name: \_\_\_\_\_ Date: \_\_\_\_\_

Club #: \_\_\_\_\_ Club Name: \_\_\_\_\_ Team Name: \_\_\_\_\_

Seed Time: \_\_\_\_\_  Standard  Variety Captain: \_\_\_\_\_ Phone #: \_\_\_\_\_  P/U \_\_\_\_\_ Initial

P/U	Dog's Name	RUN #	Breed	Jump Ht.	Owner's Name / Club (if P/U)
1	<input type="checkbox"/>				
2	<input type="checkbox"/>				
3	<input type="checkbox"/>				
4	<input type="checkbox"/>				
5	<input type="checkbox"/>				
6	<input type="checkbox"/>				
E					

Race #: \_\_\_\_\_ Race format: \_\_\_\_\_ / \_\_\_\_\_ Opponent: \_\_\_\_\_

Heat:	Lineup (Circle Dog # from above):	Result (Circle one) / Reason	Time:	Title Points:	Tourn. Scoring:
1	1 2 3 4 5 6 E	W L T NF INT B/O EST F			/
2	1 2 3 4 5 6 E	W L T NF INT B/O EST F			
3	1 2 3 4 5 6 E	W L T NF INT B/O EST F			
4	1 2 3 4 5 6 E	W L T NF INT B/O EST F			
5	1 2 3 4 5 6 E	W L T NF INT B/O EST F			
					Total Title Pts:

Race #: \_\_\_\_\_ Race format: \_\_\_\_\_ / \_\_\_\_\_ Opponent: \_\_\_\_\_

Heat:	Lineup (Circle Dog # from above):	Result (Circle one) / Reason	Time:	Title Points:	Tourn. Scoring:
1	1 2 3 4 5 6 E	W L T NF INT B/O EST F			/
2	1 2 3 4 5 6 E	W L T NF INT B/O EST F			
3	1 2 3 4 5 6 E	W L T NF INT B/O EST F			
4	1 2 3 4 5 6 E	W L T NF INT B/O EST F			
5	1 2 3 4 5 6 E	W L T NF INT B/O EST F			
					Total Title Pts:

Race #: \_\_\_\_\_ Race format: \_\_\_\_\_ / \_\_\_\_\_ Opponent: \_\_\_\_\_

Heat:	Lineup (Circle Dog # from above):	Result (Circle one) / Reason	Time:	Title Points:	Tourn. Scoring:
1	1 2 3 4 5 6 E	W L T NF INT B/O EST F			/
2	1 2 3 4 5 6 E	W L T NF INT B/O EST F			
3	1 2 3 4 5 6 E	W L T NF INT B/O EST F			
4	1 2 3 4 5 6 E	W L T NF INT B/O EST F			
5	1 2 3 4 5 6 E	W L T NF INT B/O EST F			
					Total Title Pts:

Race #: \_\_\_\_\_ Race format: \_\_\_\_\_ / \_\_\_\_\_ Opponent: \_\_\_\_\_

Heat:	Lineup (Circle Dog # from above):	Result (Circle one) / Reason	Time:	Title Points:	Tourn. Scoring:
1	1 2 3 4 5 6 E	W L T NF INT B/O EST F			/
2	1 2 3 4 5 6 E	W L T NF INT B/O EST F			
3	1 2 3 4 5 6 E	W L T NF INT B/O EST F			
4	1 2 3 4 5 6 E	W L T NF INT B/O EST F			
5	1 2 3 4 5 6 E	W L T NF INT B/O EST F			
					Total Title Pts:

Race #: \_\_\_\_\_ Race format: \_\_\_\_\_ / \_\_\_\_\_ Opponent: \_\_\_\_\_

Heat:	Lineup (Circle Dog # from above):	Result (Circle one) / Reason	Time:	Title Points:	Tourn. Scoring:
1	1 2 3 4 5 6 E	W L T NF INT B/O EST F			/
2	1 2 3 4 5 6 E	W L T NF INT B/O EST F			
3	1 2 3 4 5 6 E	W L T NF INT B/O EST F			
4	1 2 3 4 5 6 E	W L T NF INT B/O EST F			
5	1 2 3 4 5 6 E	W L T NF INT B/O EST F			
					Total Title Pts:

Race #: \_\_\_\_\_ Race format: \_\_\_\_\_ / \_\_\_\_\_ Opponent: \_\_\_\_\_

Heat:	Lineup (Circle Dog # from above):	Result (Circle one) / Reason	Time:	Title Points:	Tourn. Scoring:
1	1 2 3 4 5 6 E	W L T NF INT B/O EST F			/
2	1 2 3 4 5 6 E	W L T NF INT B/O EST F			
3	1 2 3 4 5 6 E	W L T NF INT B/O EST F			
4	1 2 3 4 5 6 E	W L T NF INT B/O EST F			
5	1 2 3 4 5 6 E	W L T NF INT B/O EST F			
					Total Title Pts:

**Teams times**  
19.999 seconds and under  
20 seconds up to 24.999 seconds

**Points earned**  
30 points per heat  
25 points per heat

**Teams times**  
25 seconds up to 29.999 seconds  
30 seconds up to 35.000 seconds

**Points earned**  
15 points per heat  
10 points per heat

**Total Score** \_\_\_\_\_

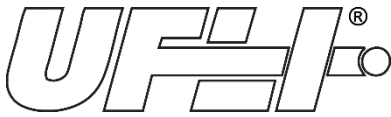

# NOVICE JUNIOR AWARD OF MERIT VERIFICATION FORM

## Junior Participant Information

<b>Name:</b>
<b>U-FLI Club Affiliation (if applicable):</b>
<b>Address:</b>
<b>City/State/Zip:</b>

## Accomplishments / Contributions at this Event

**Check All That Apply:**

<input type="checkbox"/> Ball Shagging	<input type="checkbox"/> Line Judging	<input type="checkbox"/> Other: _____
<input type="checkbox"/> Box Judging	<input type="checkbox"/> Scribe/Reaction Times	_____
<input type="checkbox"/> Calling Passes	<input type="checkbox"/> Scorekeeping	_____
<input type="checkbox"/> Handling a Dog	<input type="checkbox"/> Team Management Assistance	_____

**Special Comments (optional):**

## U-FLI Tournament Information

<b>Tournament Name / Location:</b>
<b>Date:</b>
<b>Host Club:</b>

## Signature / Verification

This document must be signed by the Tournament Director, U-FLI™ Representative, or Head Judge present at this event. The signature on this document verifies that the Junior Participant has met the requirements for the Novice Junior Award of Merit Certificate (See U-FLI™ Rule 7.4).

Signature: \_\_\_\_\_ Date: \_\_\_\_\_

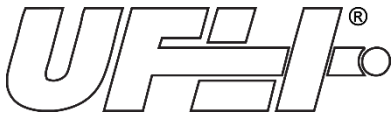

# INTERMEDIATE JUNIOR AWARD OF MERIT VERIFICATION FORM

## Junior Participant Information

<b>Name:</b>	
<b>U-FLI Club Affiliation (if applicable):</b>	
<b>Address:</b>	<b>City/State/Zip:</b>

## Accomplishments / Contributions

**Instructions: To be used after completion of the Novice Junior Award of Merit requirements.**  
 For each event listed, the U-FLI™ Representative, Tournament Director, or Head Judge must sign this document to verify the Junior Participant's Accomplishments / Contributions at each event (See U-FLI™ Rule 7.4). Once 5 signatures have been obtained on 5 separate event weekends, this original form should be mailed to the U-FLI™ address for award processing or can be given to the U-FLI Rep at the tournament.

**EVENT #1 - Check All That Apply:**

<input type="checkbox"/> Ball Shagging	<input type="checkbox"/>	Handling a Dog	<input type="checkbox"/>	Scorekeeping
<input type="checkbox"/> Box Judging	<input type="checkbox"/>	Line Judging	<input type="checkbox"/>	Team Management Assistance
<input type="checkbox"/> Calling Passes	<input type="checkbox"/>	Scribe/Reaction Times	<input type="checkbox"/>	Other:

Tournament Name/Location: \_\_\_\_\_ Host Club: \_\_\_\_\_

Signature / Verification: \_\_\_\_\_ Date: \_\_\_\_\_

---

**EVENT #2 - Check All That Apply:**

<input type="checkbox"/> Ball Shagging	<input type="checkbox"/>	Handling a Dog	<input type="checkbox"/>	Scorekeeping
<input type="checkbox"/> Box Judging	<input type="checkbox"/>	Line Judging	<input type="checkbox"/>	Team Management Assistance
<input type="checkbox"/> Calling Passes	<input type="checkbox"/>	Scribe/Reaction Times	<input type="checkbox"/>	Other:

Tournament Name/Location: \_\_\_\_\_ Host Club: \_\_\_\_\_

Signature / Verification: \_\_\_\_\_ Date: \_\_\_\_\_

---

**EVENT #3 - Check All That Apply:**

<input type="checkbox"/> Ball Shagging	<input type="checkbox"/>	Handling a Dog	<input type="checkbox"/>	Scorekeeping
<input type="checkbox"/> Box Judging	<input type="checkbox"/>	Line Judging	<input type="checkbox"/>	Team Management Assistance
<input type="checkbox"/> Calling Passes	<input type="checkbox"/>	Scribe/Reaction Times	<input type="checkbox"/>	Other:

Tournament Name/Location: \_\_\_\_\_ Host Club: \_\_\_\_\_

Signature / Verification: \_\_\_\_\_ Date: \_\_\_\_\_

---

**EVENT #4 - Check All That Apply:**

<input type="checkbox"/> Ball Shagging	<input type="checkbox"/>	Handling a Dog	<input type="checkbox"/>	Scorekeeping
<input type="checkbox"/> Box Judging	<input type="checkbox"/>	Line Judging	<input type="checkbox"/>	Team Management Assistance
<input type="checkbox"/> Calling Passes	<input type="checkbox"/>	Scribe/Reaction Times	<input type="checkbox"/>	Other:

Tournament Name/Location: \_\_\_\_\_ Host Club: \_\_\_\_\_

Signature / Verification: \_\_\_\_\_ Date: \_\_\_\_\_

---

**EVENT #5 - Check All That Apply:**

<input type="checkbox"/> Ball Shagging	<input type="checkbox"/>	Handling a Dog	<input type="checkbox"/>	Scorekeeping
<input type="checkbox"/> Box Judging	<input type="checkbox"/>	Line Judging	<input type="checkbox"/>	Team Management Assistance
<input type="checkbox"/> Calling Passes	<input type="checkbox"/>	Scribe/Reaction Times	<input type="checkbox"/>	Other:

Tournament Name/Location: \_\_\_\_\_ Host Club: \_\_\_\_\_

Signature / Verification: \_\_\_\_\_ Date: \_\_\_\_\_

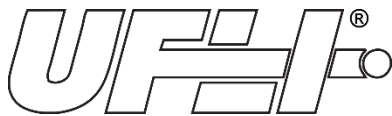

# ADVANCED JUNIOR AWARD OF MERIT VERIFICATION FORM

## Junior Participant Information

<b>Name:</b>	
<b>U-FLI Club Affiliation (if applicable):</b>	
<b>Address:</b>	<b>City/State/Zip:</b>

## Accomplishments / Contributions

**Instructions: To be used after completion of the Intermediate Junior Award of Merit requirements.**  
 For each event listed, the U-FLI™ Representative, Tournament Director, or Head Judge must sign this document to verify the Junior Participant's Accomplishments / Contributions at each event (See U-FLI™ Rule 7.4). Once 5 signatures have been obtained on 5 separate event weekends, this original form should be mailed to the U-FLI™ address for award processing or can be given to the U-FLI Rep at the tournament.

**EVENT #1 - Check All That Apply:**

<input type="checkbox"/> Ball Shagging	<input type="checkbox"/>	Handling a Dog	<input type="checkbox"/>	Scorekeeping
<input type="checkbox"/> Box Judging	<input type="checkbox"/>	Line Judging	<input type="checkbox"/>	Team Management Assistance
<input type="checkbox"/> Calling Passes	<input type="checkbox"/>	Scribe/Reaction Times	<input type="checkbox"/>	Other:

Tournament Name/Location: \_\_\_\_\_ Host Club: \_\_\_\_\_

Signature / Verification: \_\_\_\_\_ Date: \_\_\_\_\_

**EVENT #2 - Check All That Apply:**

<input type="checkbox"/> Ball Shagging	<input type="checkbox"/>	Handling a Dog	<input type="checkbox"/>	Scorekeeping
<input type="checkbox"/> Box Judging	<input type="checkbox"/>	Line Judging	<input type="checkbox"/>	Team Management Assistance
<input type="checkbox"/> Calling Passes	<input type="checkbox"/>	Scribe/Reaction Times	<input type="checkbox"/>	Other:

Tournament Name/Location: \_\_\_\_\_ Host Club: \_\_\_\_\_

Signature / Verification: \_\_\_\_\_ Date: \_\_\_\_\_

**EVENT #3 - Check All That Apply:**

<input type="checkbox"/> Ball Shagging	<input type="checkbox"/>	Handling a Dog	<input type="checkbox"/>	Scorekeeping
<input type="checkbox"/> Box Judging	<input type="checkbox"/>	Line Judging	<input type="checkbox"/>	Team Management Assistance
<input type="checkbox"/> Calling Passes	<input type="checkbox"/>	Scribe/Reaction Times	<input type="checkbox"/>	Other:

Tournament Name/Location: \_\_\_\_\_ Host Club: \_\_\_\_\_

Signature / Verification: \_\_\_\_\_ Date: \_\_\_\_\_

**EVENT #4 - Check All That Apply:**

<input type="checkbox"/> Ball Shagging	<input type="checkbox"/>	Handling a Dog	<input type="checkbox"/>	Scorekeeping
<input type="checkbox"/> Box Judging	<input type="checkbox"/>	Line Judging	<input type="checkbox"/>	Team Management Assistance
<input type="checkbox"/> Calling Passes	<input type="checkbox"/>	Scribe/Reaction Times	<input type="checkbox"/>	Other:

Tournament Name/Location: \_\_\_\_\_ Host Club: \_\_\_\_\_

Signature / Verification: \_\_\_\_\_ Date: \_\_\_\_\_

**EVENT #5 - Check All That Apply:**

<input type="checkbox"/> Ball Shagging	<input type="checkbox"/>	Handling a Dog	<input type="checkbox"/>	Scorekeeping
<input type="checkbox"/> Box Judging	<input type="checkbox"/>	Line Judging	<input type="checkbox"/>	Team Management Assistance
<input type="checkbox"/> Calling Passes	<input type="checkbox"/>	Scribe/Reaction Times	<input type="checkbox"/>	Other:

Tournament Name/Location: \_\_\_\_\_ Host Club: \_\_\_\_\_

Signature / Verification: \_\_\_\_\_ Date: \_\_\_\_\_



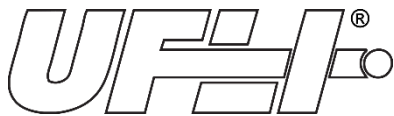

# HEIGHT MEAUREMENTS

Host Club / Tournament Name: \_\_\_\_\_ Date: \_\_\_\_\_

U-FLI Tournament #: \_\_\_\_\_

	Club Name	Dog's Name	RUN #	Breed	Jump Height
1					
2					
3					
4					
5					
6					
7					
8					
9					
10					
11					
12					
13					
14					
15					
16					
17					
18					
19					
20					
21					
22					

U-FLI Head Judge: \_\_\_\_\_ Head Judge's Signature: \_\_\_\_\_ Date: \_\_\_\_\_



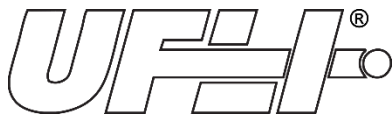

## Excusal Form - Dog

Dog's Information	
Dog's Name:	Breed/Description:
Registered To:	U-FLI Club Affiliation (if applicable):
Address:	U-FLI Club # (if applicable):
City/State/Zip:	RUN #:
Phone #:	

Excusal Information	
<b>Reason for Excusal:</b>	
<input type="checkbox"/> Aggression	<input type="checkbox"/> Less Than 12 Months of Age
<input type="checkbox"/> Lameness – Describe:	<input type="checkbox"/> Safety Concern
<input type="checkbox"/> In Heat	<input type="checkbox"/> Other – Describe:
<b>Incident Detail:</b>	
Date:	Time:                      Race #:                      Vs.
<input type="checkbox"/> Head Judge or <input type="checkbox"/> U-FLI Representative please describe:	
<input type="checkbox"/> Check if injuries were sustained – Describe:	
<input type="checkbox"/> Check if medical attention was required – Describe:	

Witness Information	
Name:	Phone #:
Describe the incident you witnessed:	
Signature:	Date:
Name:	Phone #:
Describe the incident you witnessed:	
Signature:	Date:

Tournament Information		
Event #:	Host Club / Event Location:	Tournament Director:

Judge's Signature: \_\_\_\_\_ Handler's Signature: \_\_\_\_\_

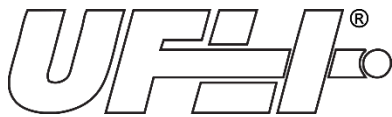

## Excusal Form - Participant

Participant's Information	
Name:	<input type="checkbox"/> Owner <input type="checkbox"/> Handler <input type="checkbox"/> Judge <input type="checkbox"/> Other – Describe:
Address:	
City/State/Zip:	U-FLI Club Affiliation (if applicable):
Phone #:	U-FLI Club # (if applicable):

Excusal Information	
<b>Reason for Excusal:</b> <input type="checkbox"/> Unsportsmanlike Conduct <input type="checkbox"/> Safety Concern <input type="checkbox"/> Abusive Treatment <input type="checkbox"/> Other – Describe:	
<b>Incident Detail:</b> Date:                      Time:                      Race #:                      Vs.	
<input type="checkbox"/> Head Judge or <input type="checkbox"/> U-FLI Representative please describe:	

Witness Information	
Name:	Phone #:
Describe the incident you witnessed:	
Signature:	Date:
Name:	Phone #:
Describe the incident you witnessed:	
Signature:	Date:

Tournament Information		
Event #:	Host Club / Event Location:	Tournament Director:

Judge's Signature: \_\_\_\_\_ Handler's Signature: \_\_\_\_\_

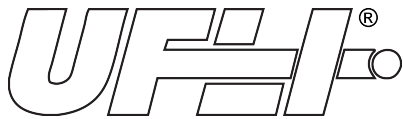

## U-FLI RECORD VERIFICATION FORM

Club Name: \_\_\_\_\_ U-FLI Club #: \_\_\_\_\_

Recorded Time: \_\_\_\_\_ Class:     Standard             Variety

Date: \_\_\_\_\_ Race #: \_\_\_\_\_

Dog's Name	RUN #	Breed	Jump Height	Participant

Event Information	
Host Club:	Host Club #:
Event Date:	Location:
Tournament Director:	Event Number:

To Be Completed by the Head Judge																																	
Judge's Name: _____																																	
<b>Please check the appropriate boxes:</b>																																	
<table style="width: 100%;"> <tr> <td style="width: 33%;">Yes</td> <td style="width: 33%;">No</td> <td style="width: 33%;">N/A</td> <td></td> </tr> <tr> <td><input type="checkbox"/></td> <td><input type="checkbox"/></td> <td><input type="checkbox"/></td> <td>Outstanding Infractions</td> </tr> <tr> <td><input type="checkbox"/></td> <td><input type="checkbox"/></td> <td><input type="checkbox"/></td> <td>4 Different Breeds (Variety)</td> </tr> <tr> <td><input type="checkbox"/></td> <td><input type="checkbox"/></td> <td><input type="checkbox"/></td> <td>Correct time copied from the DTS</td> </tr> </table>	Yes	No	N/A		<input type="checkbox"/>	<input type="checkbox"/>	<input type="checkbox"/>	Outstanding Infractions	<input type="checkbox"/>	<input type="checkbox"/>	<input type="checkbox"/>	4 Different Breeds (Variety)	<input type="checkbox"/>	<input type="checkbox"/>	<input type="checkbox"/>	Correct time copied from the DTS	<table style="width: 100%;"> <tr> <td style="width: 33%;">Yes</td> <td style="width: 33%;">No</td> <td style="width: 33%;">N/A</td> <td></td> </tr> <tr> <td><input type="checkbox"/></td> <td><input type="checkbox"/></td> <td><input type="checkbox"/></td> <td>Proper Jump Heights</td> </tr> <tr> <td><input type="checkbox"/></td> <td><input type="checkbox"/></td> <td><input type="checkbox"/></td> <td>Box Placement Validated</td> </tr> <tr> <td><input type="checkbox"/></td> <td><input type="checkbox"/></td> <td><input type="checkbox"/></td> <td>Recording given immediately to the U-FLI Representative</td> </tr> </table>	Yes	No	N/A		<input type="checkbox"/>	<input type="checkbox"/>	<input type="checkbox"/>	Proper Jump Heights	<input type="checkbox"/>	<input type="checkbox"/>	<input type="checkbox"/>	Box Placement Validated	<input type="checkbox"/>	<input type="checkbox"/>	<input type="checkbox"/>	Recording given immediately to the U-FLI Representative
Yes	No	N/A																															
<input type="checkbox"/>	<input type="checkbox"/>	<input type="checkbox"/>	Outstanding Infractions																														
<input type="checkbox"/>	<input type="checkbox"/>	<input type="checkbox"/>	4 Different Breeds (Variety)																														
<input type="checkbox"/>	<input type="checkbox"/>	<input type="checkbox"/>	Correct time copied from the DTS																														
Yes	No	N/A																															
<input type="checkbox"/>	<input type="checkbox"/>	<input type="checkbox"/>	Proper Jump Heights																														
<input type="checkbox"/>	<input type="checkbox"/>	<input type="checkbox"/>	Box Placement Validated																														
<input type="checkbox"/>	<input type="checkbox"/>	<input type="checkbox"/>	Recording given immediately to the U-FLI Representative																														
Signature: _____	Date: _____																																

To Be Completed by the U-FLI Validation Committee																															
Date Received: _____																															
<table style="width: 100%;"> <tr> <td style="width: 33%;">Yes</td> <td style="width: 33%;">No</td> <td></td> </tr> <tr> <td><input type="checkbox"/></td> <td><input type="checkbox"/></td> <td>Validated RUN's for each dog</td> </tr> <tr> <td><input type="checkbox"/></td> <td><input type="checkbox"/></td> <td>Club, Dogs, and Handlers in good standing</td> </tr> <tr> <td><input type="checkbox"/></td> <td><input type="checkbox"/></td> <td>Continuous, unedited recording</td> </tr> <tr> <td><input type="checkbox"/></td> <td><input type="checkbox"/></td> <td>Clear, good quality recording</td> </tr> </table>	Yes	No		<input type="checkbox"/>	<input type="checkbox"/>	Validated RUN's for each dog	<input type="checkbox"/>	<input type="checkbox"/>	Club, Dogs, and Handlers in good standing	<input type="checkbox"/>	<input type="checkbox"/>	Continuous, unedited recording	<input type="checkbox"/>	<input type="checkbox"/>	Clear, good quality recording	<table style="width: 100%;"> <tr> <td style="width: 33%;">Yes</td> <td style="width: 33%;">No</td> <td></td> </tr> <tr> <td><input type="checkbox"/></td> <td><input type="checkbox"/></td> <td>Acceptable view of the start/finish line</td> </tr> <tr> <td><input type="checkbox"/></td> <td><input type="checkbox"/></td> <td>Each pass validated</td> </tr> <tr> <td><input type="checkbox"/></td> <td><input type="checkbox"/></td> <td>No dropped balls</td> </tr> <tr> <td><input type="checkbox"/></td> <td><input type="checkbox"/></td> <td>No handlers thru start/finish line</td> </tr> </table>	Yes	No		<input type="checkbox"/>	<input type="checkbox"/>	Acceptable view of the start/finish line	<input type="checkbox"/>	<input type="checkbox"/>	Each pass validated	<input type="checkbox"/>	<input type="checkbox"/>	No dropped balls	<input type="checkbox"/>	<input type="checkbox"/>	No handlers thru start/finish line
Yes	No																														
<input type="checkbox"/>	<input type="checkbox"/>	Validated RUN's for each dog																													
<input type="checkbox"/>	<input type="checkbox"/>	Club, Dogs, and Handlers in good standing																													
<input type="checkbox"/>	<input type="checkbox"/>	Continuous, unedited recording																													
<input type="checkbox"/>	<input type="checkbox"/>	Clear, good quality recording																													
Yes	No																														
<input type="checkbox"/>	<input type="checkbox"/>	Acceptable view of the start/finish line																													
<input type="checkbox"/>	<input type="checkbox"/>	Each pass validated																													
<input type="checkbox"/>	<input type="checkbox"/>	No dropped balls																													
<input type="checkbox"/>	<input type="checkbox"/>	No handlers thru start/finish line																													
<input type="checkbox"/> Accepted <input type="checkbox"/> Declined – Reason: _____																															
Reviewed by: _____	Date: _____																														